



Lockbolts, Structural Blind Fasteners and Tooling



Holding Your World Together

Collar material
swaged into the
lockgrooves forming
a permanent,
vibration-resistant,
consistent clamp

Tensile

Lockbolt
before installation

Breakneck
groove

Pin
tail

Pin

Collar





Huck® is more than just high-strength fasteners. We provide solutions for precision-engineered, vibration-resistant joining. Whether it's designed for parabolic troughs or for reliable, cost-effective fleet maintenance, Huck is the strongest, most trusted fastening solution in the world. We are proud to offer you the full Huck line with flexible, convenient ordering options.

Table of Contents

HuckBolt®	4	Magna-Bulb®	35
BobTail®	7	HuckLok®	38
C50L®	12	Auto-Bulb®	41
C6L®	16	Magna-Tite®	43
Magna-Grip®	21	BOM®	46
Hucktainer®	25	FloorTight®	49
Huck Structural Blind Rivets	30	Huck® Tools	52
Magna-Lok®	31		

HuckBolts®

It's the proven reliable, vibration-resistant locking performance that has made the Huck® brand famous.

You'll find it in every HuckBolt®. Delivering uniform, consistent clamp load and high shear and tensile strength, HuckBolts are ideal for applications ranging from general manufacturing to high-vibration environments such as HVAC, trailer and container assembly, rotating equipment, shopping carts, railroad and transit cars, geodesic structures, and many others.

HuckBolts feature an exclusive locking groove design that ensures a tight, permanent fit. In addition to superior fastening performance regardless of which lockbolt type you require, HuckBolts have been proven to reduce labor and installation costs, along with rework and warranty expenses. Stronger, easier to install, and more durable than welding, adhesives, or conventional threaded fastening systems, HuckBolts have been the professionals' choice for decades.



A Strong Family of Fasteners

Engineered for a wide range of applications, HuckBolts deliver superior joining strength, shear, and tensile strength for an unmatched fastening solution.



BobTail®

Huck's swaged-on fastener with no break-off pintail. Corrosion resistant and installs with lightweight ergonomic tooling.



C50L®

Superior vibration resistance and durability for heavy-duty applications.



C6L®/C120L/C150L

The classic 6-groove locking fastener ideal for a wide range of applications. Available in grades, 2, 5, and 8.



Hucktainer®

Panel fastener that installs with consistent pressure, reducing crushing or cracking.



Magna-Grip®

Vibration-resistant, reliable grade 2 fasteners offering high, uniform, installed values with a wide grip range.

Common Huck® Product Coatings

For Huck® Rivet Mandrels and Sleeves, HuckBolts® and Collars/Nuts



COLOR: Black
MATERIAL: Steel
FINISH: Zinc Electroplate, Black Dyed Trivalent Chromate

PRODUCT(S)	ASTM B117 MIN HOURS
BL - Collars, Sleeves, Non-Grade 8 HuckBolts®	72
BLX - Collars and Non-Grade 8 HuckBolts (BL with 1 Coat of HuckGuard®)	500
BL2X - 3/8" and Larger Collars and Non-Grade 8 HuckBolts (BL with 2 Coats of HuckGuard®)	1000



COLOR: Silver
MATERIAL: Steel
FINISH: Geomet 321, Organic Top Coat

PRODUCT(S)	ASTM B117 MIN HOURS
NP - Bolts and Mandrels (1 Coat Geomet)	48
D1 - 1/4" and larger Bolts and Mandrels (2 Coats Geomet)	500
DL - 3/8" and larger Bolts, Excluding Huck 360 (3 Coats Geomet)	1000



COLOR: Silver
MATERIAL: Steel
FINISH: Zinc Electroplate, Trivalent Chromate

PRODUCT(S)	ASTM B117 MIN HOURS
GA - Collars, Sleeves, Non-Grade 8 HuckBolts®	72
GAX - Collars and Non-Grade 8 HuckBolts (GA with 1 Coat of HuckGuard®)	500
GA2X - 3/8" and Larger Collars and Non-Grade 8 HuckBolts (GA with 2 Coats of HuckGuard®)	1000



COLOR: Shiny or Flat Black
MATERIAL: Steel
FINISH: Blackened Oil

PRODUCT(S)	ASTM B117 MIN HOURS
All HuckBolt® Sizes	Transit and storage protection only



COLOR: Yellow
MATERIAL: Steel
FINISH: Zinc Electroplate, Yellow Dyed Trivalent Chromate

PRODUCT(S)	ASTM B117 MIN HOURS
UA - Collars, Sleeves, Non-Grade 8 HuckBolts®	96
UAX - Collars and Non-Grade 8 HuckBolts (UA with 1 Coat of HuckGuard®)	500
UA2X - 3/8" and Larger Collars and Non-Grade 8 HuckBolts (UA with 2 Coats of HuckGuard®)	1000

For more coatings, request a full list. Custom coatings available.

BobTail®

Huck's Next-Generation, Pintail-Less HuckBolt

Representing the most advanced fastening technology to date, the BobTail® delivers the highest level of performance and reliability.

Engineered to meet the challenges of a wide range of assembly applications, BobTail offers safe, quiet, swaged-on installation technology in a unique, pintail-less design. Available in an assortment of sizes, in both Grade 5 and Grade 8. BobTail offers 5 times the fatigue strength of conventional nuts and bolts and unmatched installation speed – often under 2 seconds per fastener.

Its unique no-break-off pintail offers the highest corrosion-resistance in its class, while advanced, low-swage technology enables installation with lightweight, ergonomic tools. When you factor in the cost of fasteners with installation and inspection labor, BobTail often provides an overall lower installed cost.

Available Sizes 1/4", 5/16", 3/8", 1/2", 5/8", 3/4", 7/8", 1"
12mm, 14mm, 16mm, 20mm

Materials Steel, Aluminum, Stainless Steel

Headstyles Round, Truss, 90° Flush, Flanged, 98T, Trazier

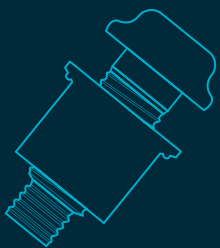
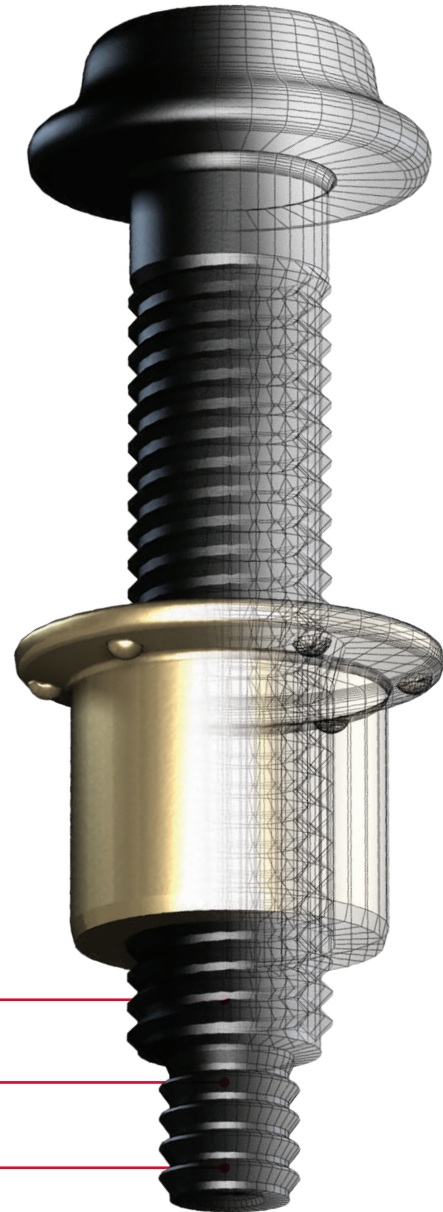

- ✓ No pintail
- ✓ Maintenance Free
- ✓ Low overall installed cost
- ✓ Superior strength (fatigue)
- ✓ Vibration resistance
- ✓ Quiet installation
- ✓ No repetitive stress injuries
- ✓ No special training or skills required for installation personnel
- ✓ Quick visual inspection is all that's needed for a quality-assured joint

Easy Visual Inspection

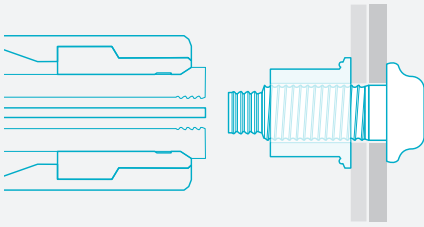

Insert pin into the prepared hole, spin the collar onto the pin.

1

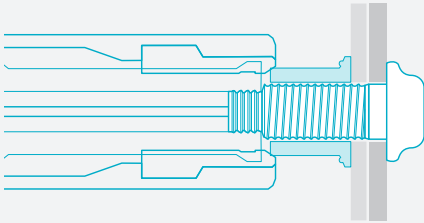

The installation tool is applied to annular pull grooves. When the tool is activated, a puller in the nose assembly draws the pin into the tool, causing the swaging anvil to press on the collar, drawing up any sheet gap.

2

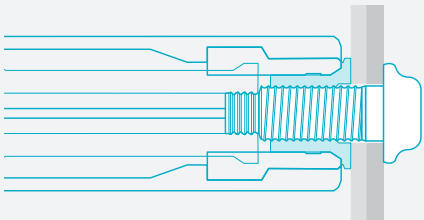

At a predetermined force, the anvil begins to swage the collar into the pin's lockgrooves. Continued swaging elongates the collar and pin, developing precise clamp.

3

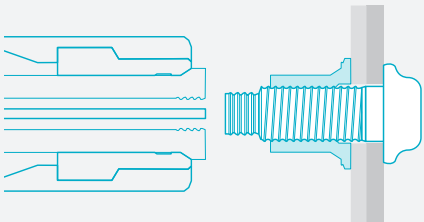

When swaging of the collar into the pin lockgrooves is complete, the tool ejects the fastener and releases the puller to complete the sequence.

4

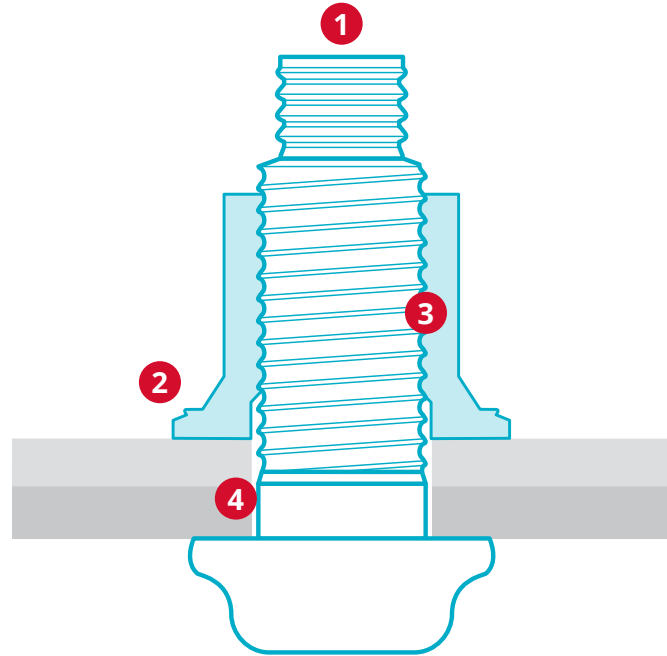

- 1** Pintail-less design means reduced noise, no waste, and improved corrosion resistance.
- 2** Visual evidence of successful installation provided by installation indicator.
- 3** Collar material swaged into the lockgrooves forms a permanent, vibration-resistant connection.
- 4** Low-swage technology allows for faster, lighter, ergonomic tooling with parts that last longer.

BobTail®

Data and Dimensions

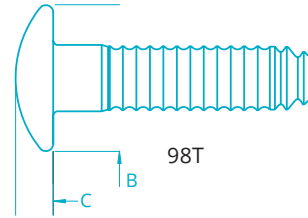

Steel

DIAMETER	PART NO.	GRIP RANGE	MAX HOLE SIZE	[B] HEAD DIA	[C] HEAD HEIGHT	MINIMUM SHEAR (LBF)	MINIMUM CLAMP (LBF)	MINIMUM TENSILE (LBF)
98T								
1/4"	BT98T-R8-2GA	0-.250	.281	.530-.595	.135-.155	3050	1805	3000
	BT98T-R8-3GA	.063-.312	.281	.530-.595	.135-.155	3050	1805	3000
	BT98T-R8-4GA	.125-.375	.281	.530-.595	.135-.155	3050	1805	3000
	BT98T-R8-5GA	.187-.437	.281	.530-.595	.135-.155	3050	1805	3000
	BT98T-R8-6GA	.250-.500	.281	.530-.595	.135-.155	3050	1805	3000
	BT98T-R8-7GA	.312-.562	.281	.530-.595	.135-.155	3050	1805	3000
	BT98T-R8-8GA	.375-.625	.281	.530-.595	.135-.155	3050	1805	3000
	BT98T-R8-10GA	.500-.750	.281	.530-.595	.135-.155	3050	1805	3000
	BT98T-R8-12GA	.625-.875	.281	.530-.595	.135-.155	3050	1805	3000
3/8"	BT98T-R12-4GA	.125-.375	.422	.775-.825	.190-.210	6825	4020	6500
	BT98T-R12-6GA	.250-.500	.422	.775-.825	.190-.210	6825	4020	6500
	BT98T-R12-8GA	.375-.625	.422	.775-.825	.190-.210	6825	4020	6500
	BT98T-R12-10GA	.500-.750	.422	.775-.825	.190-.210	6825	4020	6500
	BT98T-R12-12GA	.625-.875	.422	.775-.825	.190-.210	6825	4020	6500
	BT98T-R12-14GA	.750-1.000	.422	.775-.825	.190-.210	6825	4020	6500
	BT98T-R12-16GA	.875-1.125	.422	.775-.825	.190-.210	6825	4020	6500
	BT98T-R12-18GA	1.000-1.250	.422	.775-.825	.190-.210	6825	4020	6500

Stainless Steel

DIAMETER	PART NO.	GRIP RANGE	MAX HOLE SIZE	[B] HEAD DIA	[C] HEAD HEIGHT	MINIMUM SHEAR (LBF)	MINIMUM CLAMP (LBF)	MINIMUM TENSILE (LBF)
400 Series Stainless Polished Heads								
1/4"	BT98T-4U8-2BR	0-.250	.281	.530-.595	.135-.155	*	1805	2750
	BT98T-4U8-3BR	.063-.312	.281	.530-.595	.135-.155	*	1805	2750
	BT98T-4U8-4BR	.125-.375	.281	.530-.595	.135-.155	*	1805	2750
	BT98T-4U8-5BR	.187-.437	.281	.530-.595	.135-.155	*	1805	2750
	BT98T-4U8-6BR	.250-.500	.281	.530-.595	.135-.155	*	1805	2750
	BT98T-4U8-8BR	.375-.625	.281	.530-.595	.135-.155	2600	1805	2750
	BT98T-4U8-10BR	.500-.750	.281	.530-.595	.135-.155	2600	1805	2750
	BT98T-4U8-12BR	.625-.875	.281	.530-.595	.135-.155	2600	1805	2750
3/8"	BT98T-4U12-6BR	.250-.500	.422	.775-.825	.190-.210	6000	4020	6100
	BT98T-4U12-8BR	.375-.625	.422	.775-.825	.190-.210	6000	4020	6100
	BT98T-4U12-10BR	.500-.750	.422	.775-.825	.190-.210	6000	4020	6100
	BT98T-4U12-12BR	.625-.875	.422	.775-.825	.190-.210	6000	4020	6100
	BT98T-4U12-14BR	.750-1.000	.422	.775-.825	.190-.210	6000	4020	6100
	BT98T-4U12-16BR	.875-1.125	.422	.775-.825	.190-.210	6000	4020	6100
BT98T-4U12-20BR	1.125-1.375	.422	.775-.825	.190-.210	6000	4020	6100	

NOTE: Part numbers listed reflect typical stock. Additional Head Styles, material, diameter and grips may be available. All parts may be subject to minimum order.

* Shear test waived under 6 grip.

BobTail® Data and Dimensions

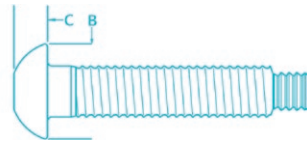

Round



Flanged



Truss

Steel - Metric

DIAMETER	PART NO.	GRIP RANGE	MAX HOLE SIZE	[B] HEAD DIA	[C] HEAD HEIGHT	MIN SHEAR (KN/LBF)	MIN CLAMP (KN/LBF)	MIN TENSILE (KN/LBF)
Flanged Head								
16MM Grade 10.9	MBT-DT16-15NP	10-20mm	17.5mm	32.3-33.8mm	11.4-12.2mm	116/26000	116/26000	163/36600
	MBT-DT16-20NP	15-25mm	17.5mm	32.3-33.8mm	11.4-12.2mm	116/26000	116/26000	163/36600
	MBT-DT16-25NP	20-30mm	17.5mm	32.3-33.8mm	11.4-12.2mm	116/26000	116/26000	163/36600
	MBT-DT16-30NP	25-35mm	17.5mm	32.3-33.8mm	11.4-12.2mm	116/26000	116/26000	163/36600
	MBT-DT16-35NP	30-40mm	17.5mm	32.3-33.8mm	11.4-12.2mm	116/26000	116/26000	163/36600
	MBT-DT16-40NP	35-45mm	17.5mm	32.3-33.8mm	11.4-12.2mm	116/26000	116/26000	163/36600
	MBT-DT16-45NP	40-50mm	17.5mm	32.3-33.8mm	11.4-12.2mm	116/26000	116/26000	163/36600
	MBT-DT16-50NP	45-55mm	17.5mm	32.3-33.8mm	11.4-12.2mm	116/26000	116/26000	163/36600
	MBT-DT16-55NP	50-60mm	17.5mm	32.3-33.8mm	11.4-12.2mm	116/26000	116/26000	163/36600
	MBT-DT16-60NP	55-65mm	17.5mm	32.3-33.8mm	11.4-12.2mm	116/26000	116/26000	163/36600
	MBT-DT16-65NP	60-70mm	17.5mm	32.3-33.8mm	11.4-12.2mm	116/26000	116/26000	163/36600
	MBT-DT16-70NP	65-75mm	17.5mm	32.3-33.8mm	11.4-12.2mm	116/26000	116/26000	163/36600
MBT-DT16-80NP	75-85mm	17.5mm	32.3-33.8mm	11.4-12.2mm	116/26000	116/26000	163/36600	
20MM Grade 10.9	MBT-DT20-20NP	15-25mm	22mm	40.3-42.4mm	15.0-16.0mm	182/41000	181/40700	255/57380
	MBT-DT20-30NP	25-35mm	22mm	40.3-42.4mm	15.0-16.0mm	182/41000	181/40700	255/57380
	MBT-DT20-40NP	35-45mm	22mm	40.3-42.4mm	15.0-16.0mm	182/41000	181/40700	255/57380
	MBT-DT20-45NP	40-50mm	22mm	40.3-42.4mm	15.0-16.0mm	182/41000	181/40700	255/57380
	MBT-DT20-50NP	45-55mm	22mm	40.3-42.4mm	15.0-16.0mm	182/41000	181/40700	255/57380

Steel - Imperial

DIAMETER	PART NO.	GRIP RANGE	MAX HOLE SIZE	[B] HEAD DIA	[C] HEAD HEIGHT	MIN SHEAR (LBF)	MIN CLAMP (LBF)	MIN TENSILE (LBF)
Round Head								
5/8" Grade 5	BTR-BR20-4GA	.250-.620	.688	1.086-1.196	.367-.432	22500	19200	27100
	BTR-BR20-8GA	.500-.870	.688	1.086-1.196	.367-.432	22500	19200	27100
	BTR-BR20-12GA	.750-1.120	.688	1.086-1.196	.367-.432	22500	19200	27100
	BTR-BR20-16GA	1.00-1.370	.688	1.086-1.196	.367-.432	22500	19200	27100
	BTR-BR20-20GA	1.250-1.620	.688	1.086-1.196	.367-.432	22500	19200	27100
	BTR-BR20-24GA	1.500-1.870	.688	1.086-1.196	.367-.432	22500	19200	27100
Round Head								
3/4" Grade 5	BTR-BR24-8GA	.500-.870	.813	1.326-1.440	.455-.530	32400	28400	40100

Large and Small BobTail® Collars

Steel

DIAMETER	PART NO.	WIDTH (G)
1/4" with tab	BTC-R8GAHL	.485-.515
3/8" with tab	BTC-R12GAHL	.730-.770

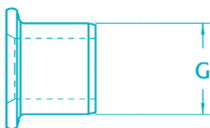

430 Stainless Steel

DIAMETER	PART NO.	WIDTH (G)
1/4" with tab	BTC-4U8L	.485-.515
3/8" with tab	BTC-4U12L	.730-.770

Steel, Zinc Plated

DIAMETER	PART NO.	WIDTH (G)
16MM	MBTC-R16BL*	32.2-33.8 mm
20MM	MBTC-R20BL*	40.3-42.1 mm
5/8"	BTC5-R20UA*	1.270-1.330
3/4"	BTC5-R24UA*	1.520-1.600

* Come standard with a fit up tab

Tab-Lok™

The optional Tab-Lok feature makes sure the collar stays on the pin, before installation, in overhead and down slanted pin placements.



BobTail® Tooling

Imperial

DIAMETER	TOOL	INSTALLATION	CUTTER
1/4"	BV4500-118 244BT SFBTT8	99-7932 99-7932 99-7930	99-7932CC 99-7932CC 99-7930CC
5/16"	256BT SFBTT8	99-7923 99-7929	99-7923CC 99-7929CC
3/8"	256BT SFBTT8	99-7924 99-7928	99-7924CC 99-7928CC
1/2"	SF20	99-7882	99-7882CX
5/8"	SF20	99-7881	99-7881CX
3/4"	SF32	99-7894	99-7893CX
7/8"	SF46	99-7863	99-7863CX
1"	SF46	99-7867	99-7867CX

Metric

DIAMETER	TOOL	INSTALLATION	CUTTER
12mm	SF20	99-7880	99-7880CX
14mm	SF20	99-7884	99-7884CX
16mm	SF20	99-7881	99-7881CX
20mm	SF32	99-7893	99-7893CX

** Other BobTail tooling options are available. Visit the Tooling Resource Center at hfsindustrial.com/tooling or call HFS at 800-278-4825 for more information.



Model SF46

Model SF20
SWAGEFORWARD®

Collar Cutter Feature

While BobTail fasteners install permanently, BobTail installation tooling features a collar cutter nosepiece that makes fastener removal easier than ever.



C50L®

The Fastener That Has Defined HuckBolts for More Than 50 years

The C50L® offers superior vibration resistance and overall durability for heavy-duty fastening jobs, and is ideal for use within applications where consistent, uniform high clamp force is required. Testing has proven that C50L fasteners meet, or exceed the performance of torqued bolts in both shear and tensile strength, as well as fatigue life. For heavy-duty applications ranging from railcar to mining equipment manufacturing, the C50L delivers superior vibration resistance and overall durability.

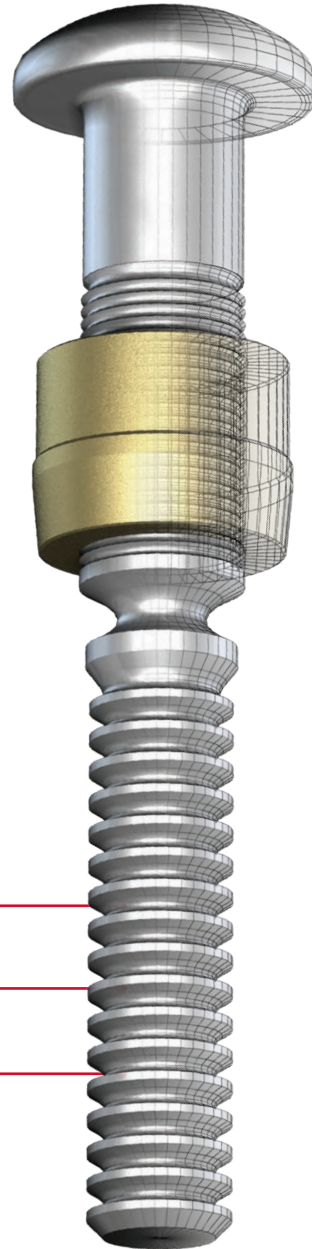

Available Sizes 1/2", 5/8", 3/4", 7/8", 1", 1-1/8", 1-3/8"

Materials Steel, Aluminum

Headstyles Round, Truss, Large Truss, 90° Flush, Thread Head

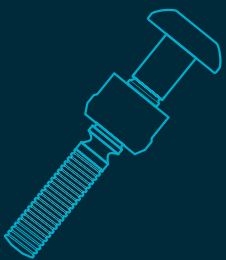

- ✓ Superior vibration resistance
- ✓ Overall durability for heavy-duty applications
- ✓ High shear and tensile strength
- ✓ High fatigue life
- ✓ Consistent, uniform clamp force

Secure, Fast Installation

Unlike threaded fasteners, the C50L HuckBolt delivers consistent installation results. High costs of calibrating, maintaining, and replacing tools are eliminated. Also, installation does not require expensive, highly experienced workers.

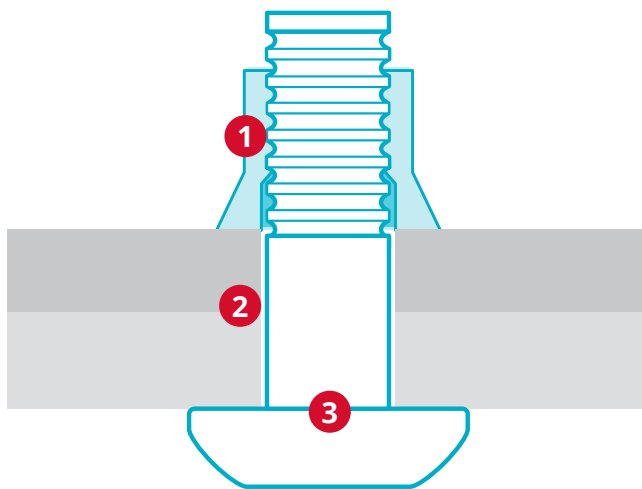

- 1 Swaged-on collar forms a permanent, vibration-proof connection.
- 2 Initial long length of fastener enables pull-out of large gaps.
- 3 Consistent, repeatable pre-load.

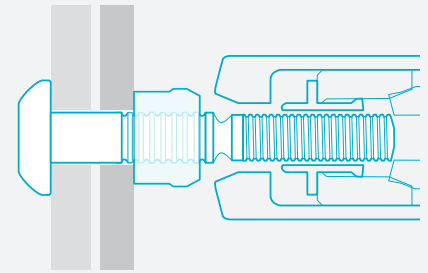

- 1 Insert pin into the prepared hole and the smooth bore collar is placed on the pin.

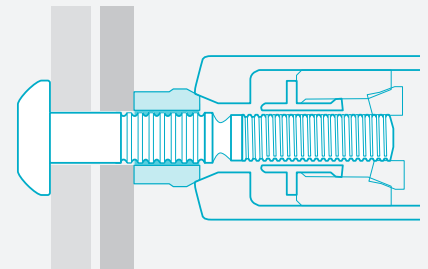

- 2 The installation tool is applied to the pintail. When the tool is activated, the jaws in the nose assembly pull on the pintail and the nose anvil pushes on the collar to remove any gap.

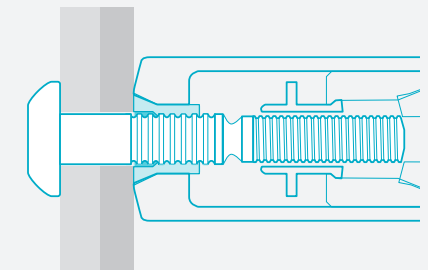

- 3 The nose anvil starts to swage the collar into the lockgrooves on the pin. Continued swaging causes the collar to lengthen and develop clamp.

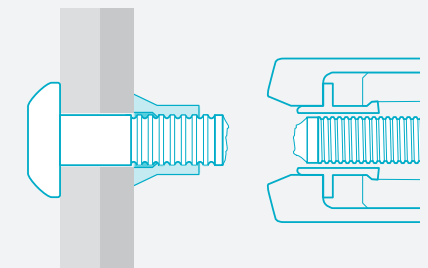

- 4 When swaging of the collar into the lockgrooves is complete, the tool ejects the fastener and releases the puller to complete the sequence.

C50L® Data and Dimensions

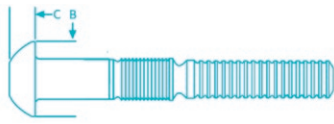

Round

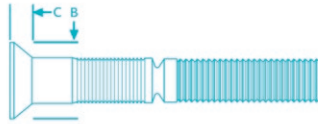

90 Degree Flush

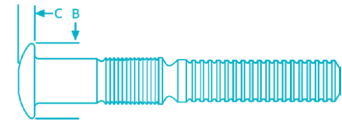

Truss Head

Steel Pin - Black

DIAMETER	PART NO.	GRIP RANGE**	MAX HOLE SIZE**	[B] HEAD DIA	[C] HEAD HEIGHT	MINIMUM SHEAR (LBF)	MINIMUM CLAMP (LBF)	MINIMUM TENSILE (LBF)
Round Head								
1/2"	C50LR-BR16-4	.250-.500	.563	.870-.940	.310-.320	14400	12050	17050
	C50LR-BR16-8	.500-.750	.563	.870-.940	.310-.320	14400	12050	17050
	C50LR-BR16-12	.750-1.000	.563	.870-.940	.310-.320	14400	12050	17050
	C50LR-BR16-16	1.000-1.250	.563	.870-.940	.310-.320	14400	12050	17050
	C50LR-BR16-20	1.250-1.500	.563	.870-.940	.310-.320	14400	12050	17050
	C50LR-BR16-24	1.500-1.750	.563	.870-.940	.310-.320	14400	12050	17050
	C50LR-BR16-28	1.750-2.000	.563	.870-.940	.310-.320	14400	12050	17050
	C50LR-BR16-32	2.000-2.250	.563	.870-.940	.310-.320	14400	12050	17050
5/8"	C50LR-BR20-4	.250-.500	.688	1.086-1.196	.367-.432	22500	19200	27100
	C50LR-BR20-8	.500-.750	.688	1.086-1.196	.367-.432	22500	19200	27100
	C50LR-BR20-12	.750-1.000	.688	1.086-1.196	.367-.432	22500	19200	27100
	C50LR-BR20-16	1.000-1.250	.688	1.086-1.196	.367-.432	22500	19200	27100
	C50LR-BR20-20	1.250-1.500	.688	1.086-1.196	.367-.432	22500	19200	27100
	C50LR-BR20-24	1.500-1.750	.688	1.086-1.196	.367-.432	22500	19200	27100
3/4"	C50LR-BR24-8	.500-.750	.813	1.328-1.438	.455-.530	32400	28400	40100
	C50LR-BR24-12	.750-1.000	.813	1.328-1.438	.455-.530	32400	28400	40100
	C50LR-BR24-16	1.000-1.250	.813	1.328-1.438	.455-.530	32400	28400	40100
	C50LR-BR24-20	1.250-1.500	.813	1.328-1.438	.455-.530	32400	28400	40100
	C50LR-BR24-24	1.500-1.750	.813	1.328-1.438	.455-.530	32400	28400	40100
	C50LR-BR24-28	1.750-2.000	.813	1.328-1.438	.455-.530	32400	28400	40100
	C50LR-BR24-32	2.000-2.250	.813	1.328-1.438	.455-.530	32400	28400	40100
	C50LR-BR24-36	2.250-2.500	.813	1.328-1.438	.455-.530	32400	28400	40100
	C50LR-BR24-40	2.500-2.750	.813	1.328-1.438	.455-.530	32400	28400	40100
7/8"	C50LR-BR28-16	1.000-1.250	.938	1.450-1.660	.530-.580	43400	39250	55450
	C50LR-BR28-20	1.250-1.500	.938	1.450-1.660	.530-.580	43400	39250	55450
	C50LR-BR28-24	1.500-1.750	.938	1.450-1.660	.530-.580	43400	39250	55450
	C50LR-BR28-28	1.750-2.000	.938	1.450-1.660	.530-.580	43400	39250	55450
	C50LR-BR28-32	2.000-2.250	.938	1.450-1.660	.530-.580	43400	39250	55450
	C50LR-BR28-36	2.250-2.500	.938	1.450-1.660	.530-.580	43400	39250	55450
	C50LR-BR28-40	2.500-2.750	.938	1.450-1.660	.530-.580	43400	39250	55450
1"	C50LR-BR32-20	1.250-1.500	1.063	1.750-2.000	.590-.650	56500	51500	72700
	C50LR-BR32-24	1.500-1.750	1.063	1.750-2.000	.590-.650	56500	51500	72700
	C50LR-BR32-28	1.750-2.000	1.063	1.750-2.000	.590-.650	56500	51500	72700
	C50LR-BR32-32	2.000-2.250	1.063	1.750-2.000	.590-.650	56500	51500	72700
	C50LR-BR32-36	2.250-2.500	1.063	1.750-2.000	.590-.650	56500	51500	72700
	C50LR-BR32-44	2.750-3.000	1.063	1.750-2.000	.590-.650	56500	51500	72700
	C50LR-BR32-48	3.000-3.250	1.063	1.750-2.000	.590-.650	56500	51500	72700
	C50LR-BR32-52	3.250-3.500	1.063	1.750-2.000	.590-.650	56500	51500	72700
	C50LR-BR32-56	3.500-3.750	1.063	1.750-2.000	.590-.650	56500	51500	72700
	C50LR-BR32-60	3.750-4.000	1.063	1.750-2.000	.590-.650	56500	51500	72700
	C50LR-BR32-64	4.000-4.250	1.063	1.750-2.000	.590-.650	56500	51500	72700
	C50LR-BR32-84	5.250-5.500	1.063	1.750-2.000	.590-.650	56500	51500	72700
C50LR-BR32-88	5.500-5.750	1.063	1.750-2.000	.590-.650	56500	51500	72700	

** Grip and max hole size calculated using LC collar from 1,000 up

NOTE: Part numbers listed reflect typical stock. Additional Head Styles, material, diameter and grips may be available. All parts may be subject to minimum order.

C50L[®] Data and Tooling

Steel Pin - Zinc Plated

DIAMETER	PART NO.	GRIP RANGE**	MAX HOLE SIZE**	[B] HEAD DIA	[C] HEAD HEIGHT	MINIMUM SHEAR (LBF)	MINIMUM CLAMP (LBF)	MINIMUM TENSILE (LBF)
Round Head								
1/2"	C50LR-BR16-4GA	.250-.500	.563	.870-.940	.310-.320	14400	12050	17050
	C50LR-BR16-8GA	.500-.750	.563	.870-.940	.310-.320	14400	12050	17050
	C50LR-BR16-12GA	.750-1.000	.563	.870-.940	.310-.320	14400	12050	17050
	C50LR-BR16-16GA	1.000-1.250	.563	.870-.940	.310-.320	14400	12050	17050
5/8"	C50LR-BR20-4GA	.250-.500	.688	1.086-1.196	.367-.432	22500	19200	27100
	C50LR-BR20-8GA	.500-.750	.688	1.086-1.196	.367-.432	22500	19200	27100
	C50LR-BR20-12GA	.750-1.000	.688	1.086-1.196	.367-.432	22500	19200	27100
	C50LR-BR20-16GA	1.000-1.250	.688	1.086-1.196	.367-.432	22500	19200	27100
3/4"	C50LR-BR20-20GA	1.250-1.500	.688	1.086-1.196	.367-.432	22500	19200	27100
	C50LR-BR24-12GA	.750-1.000	.813	1.328-1.438	.530-.580	32400	28400	40100
90° Flush Head								
5/8"	C50L90-BR20-12	.750-1.000	.688	1.093-1.183	.284-.300	22500	19200	27100
3/4"	C50L90-BR24-12	.750-1.000	.813	1.312-1.417	.350-.380	32400	28400	40100
	C50L90-BR24-16	1.000-1.250	.813	1.312-1.417	.350-.380	32400	28400	40100
	C50L90-BR24-20	1.250-1.500	.813	1.312-1.417	.350-.380	32400	28400	40100
	C50L90-BR24-24	1.500-1.750	.813	1.312-1.417	.350-.380	32400	28400	40100
	C50L90-BR24-28	1.750-2.000	.813	1.312-1.417	.350-.380	32400	28400	40100
	C50L90-BR24-32	2.000-2.250	.813	1.312-1.417	.350-.380	32400	28400	40100
80° Flush Head								
3/4"	C50L80-BR24-16	1.000-1.250	.813	1.101-1.125	.337-.357	32400	28400	40100

** Grip and max hole size calculated using LC collar from 1,000 up

Collars

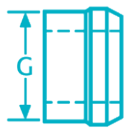

Standard

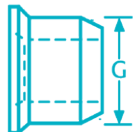

Flanged

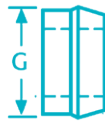

Low Profile

Steel, Zinc Plated

DIAMETER	PART NO.	WIDTH (G)
Standard, Non-Flanged		
1/2"	LC-2R16G	.765-.800
5/8"	LC-2R20G	.970-.990
3/4"	LC-2R24G	1.165-1.180
7/8"	LC-2R28G	1.355-1.375
1"	LC-2R32G	1.535-1.575
1-1/8"	LC-2R36G	1.750-1.770
Flanged		
1/2"	3LC-2R16G	.969-1.031
5/8"	3LC-2R20G	.980-1.000
5/8" with tab	3LC-2R20GANL	.980-1.000
3/4"	3LC-2R24G	1.170-1.195
7/8"	3LC-2R28G	1.360-1.370
1"	3LC-2R32G	1.550-1.575
Low Profile		
5/8"	8LC-2R20GA	.972-.982
7/8"	8LC-2R28G	1.360-1.375

Installation Tooling

DIAMETER	INSTALLATION TOOL	NOSE ASSEMBLY	TYPE
1/2"	2620	99-5000	Hydraulic
	2620-PT	99-5002	Hydraulic
5/8"	2624	99-5008	Hydraulic
	3585	99-5008	Hydraulic
3/4"	3585	99-5010	Hydraulic
7/8"	2630	99-5014	Hydraulic
1"	507	99-5016	Hydraulic
1-1/8"	507	99-5019	Hydraulic
1-3/8"	12142	Integral	Hydraulic



C6L®

The Classic 6-Groove Locking Fastener Built With Staying Power

A result of Huck International innovation a half-century ago, the versatile C6L® HuckBolt® remains the number one fastening system for applications that require a strong, vibration-resistant seal today.

C6L's exclusive locking groove design ensures a permanent fit that resists loosening. That means it's ideal for applications from general manufacturing to such high-vibration applications as HVAC, trailer and container assembly, rotary and rotating equipment, shopping carts, railroad and transit cars, geodesic structures, and many others.

In addition to offering superior fastening performance, the C6L system reduces labor and installation costs, along with rework and warranty expenses. Using the C6L eliminates the need to hire certified welders or specially trained employees because workers can be instructed to install these foolproof fasteners in a matter of minutes. The C6L is simply stronger, easier to install, and more durable than welding, adhesives, or conventional threaded fastening systems. The C6L is available in Grade 2, Grade 5, and Grade 8.

Available Sizes 3/16", 1/4", 5/16", 3/8"

Materials Steel, Aluminum, Stainless Steel

Headstyles Round, Truss, Flush, 98T

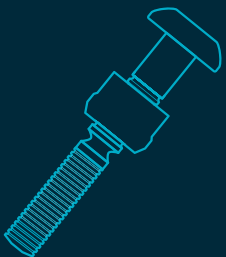
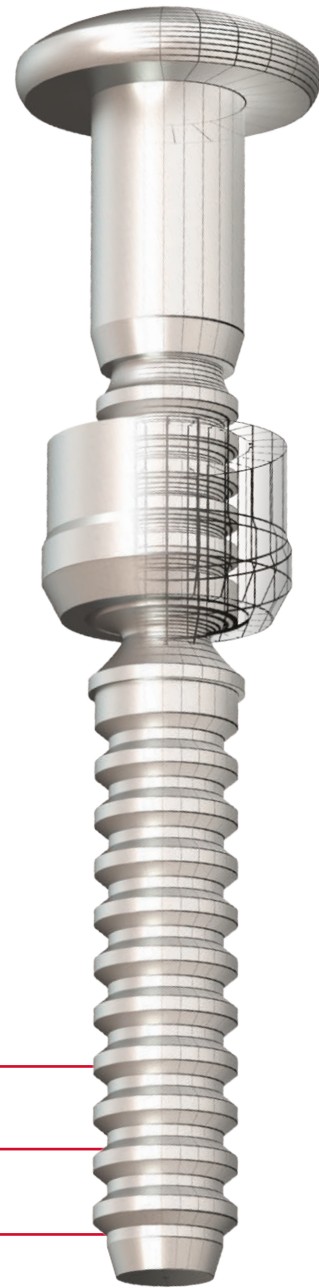

- ✓ Superior vibration resistance
- ✓ High shear and tensile strength, and fatigue life
- ✓ Heavy-duty applications
- ✓ High uniform clamp force

Secure, Fast Installation

The C6L's unique design virtually eliminates installation errors caused by operator or tool variables. The C6L ensures that once the collar swage is complete, the pintail breaks off and the fastener is tightly installed. No rework required. You can count on consistent, highly-uniform clamp force with every C6L installation, time after time.

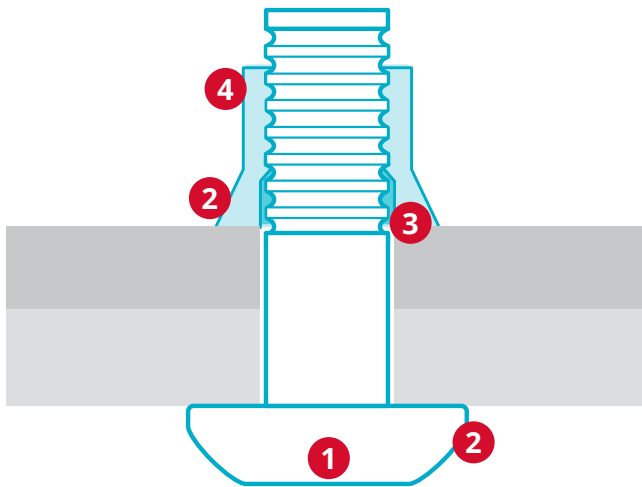

- 1 Wide bearing collar and head spread load to ensure structural integrity.
- 2 Initial long length of fastener enables pull-out of large gaps.
- 3 Excellent gap pull-out and high retained clamp.
- 4 High-fatigue, annular lock groove form extends the life of your structure.

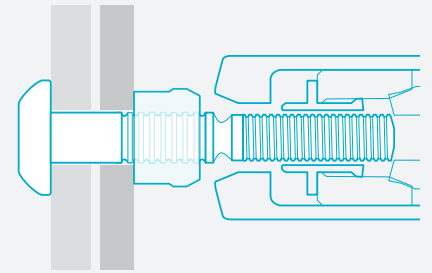

- 1 Insert pin into the prepared hole and the smooth bore collar is placed on the pin.

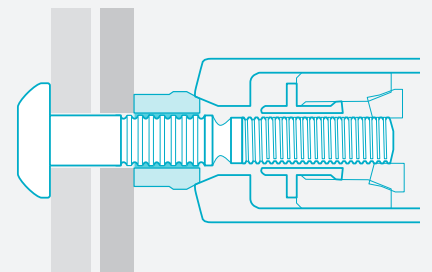

- 2 The installation tool is applied to the pintail. When the tool is activated, the jaws in the nose assembly pull on the pintail and the nose anvil pushes on the collar to remove any gap.

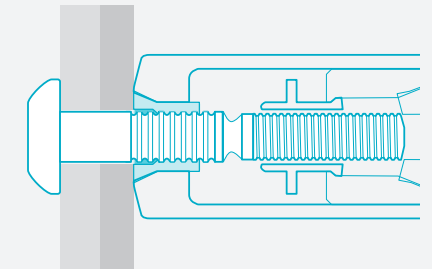

- 3 The nose anvil starts to swage the collar into the lockgrooves on the pin. Continued swaging causes the collar to lengthen and develop clamp.

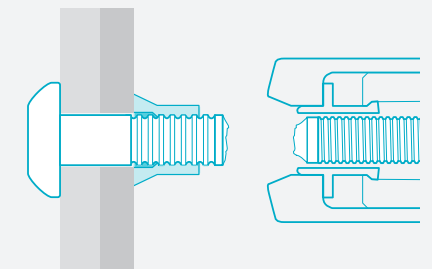

- 4 When swaging of the collar into the lockgrooves is complete, the tool ejects the fastener and releases the puller to complete the sequence.

C6L® Data and Dimensions

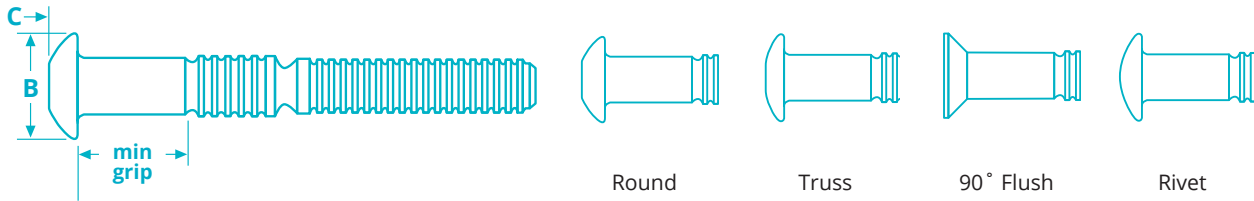

Steel Pin - Zinc Plated

DIAMETER	PART NO.	GRIP RANGE	MAX HOLE SIZE	[B] HEAD DIA	[C] HEAD HEIGHT	MIN. SHEAR (LBF)	MIN. CLAMP (LBF)	MIN. TENSILE (LBF)
Round Head								
1/4"	C6LB-R8-2G	.063-.188	.281	.475-.525	.136-.152	3050	1805	2550
	C6LB-R8-3GA	.125-.250	.281	.475-.525	.136-.152	3050	1805	2550
	C6LB-R8-4G	.188-.313	.281	.475-.525	.136-.152	3050	1805	2550
	C6LB-R8-5G	.250-.375	.281	.475-.525	.136-.152	3050	1805	2550
	C6LB-R8-6G	.313-.438	.281	.475-.525	.136-.152	3050	1805	2550
	C6LB-R8-7G	.375-.500	.281	.475-.525	.136-.152	3050	1805	2550
	C6LB-R8-8G	.438-.563	.281	.475-.525	.136-.152	3050	1805	2550
5/16"	C6LB-R10-4G	.125-.375	.359	.594-.656	.181-.201	4725	2810	4600
	C6LB-R10-6G	.250-.500	.359	.594-.656	.181-.201	4725	2810	4600
	C6LB-R10-8G	.375-.625	.359	.594-.656	.181-.201	4725	2810	4600
3/8"	C6LB-R12-4G	.125-.375	.422	.720-.780	.223-.248	6825	4020	5625
	C6LB-R12-6G	.250-.500	.422	.720-.780	.223-.248	6825	4020	5625
	C6LB-R12-8G	.375-.625	.422	.720-.780	.223-.248	6825	4020	5625
	C6LB-R12-10G	.500-.750	.422	.720-.780	.223-.248	6825	4020	5625
	C6LB-R12-12G	.625-.875	.422	.720-.780	.223-.248	6825	4020	5625
3/8"	C6LB-R12-14G	.750-1.000	.422	.720-.780	.223-.248	6825	4020	5625
Truss Head								
1/4"	C6LT-R8-4GA	.188-.313	.281	.531-.594	.103-.115	3050	1805	2550
	C6LT-R8-5GA	.250-.375	.281	.531-.594	.103-.115	3050	1805	2550
	C6LT-R8-7GA	.375-.500	.281	.531-.594	.103-.115	3050	1805	2550
	C6LT-R8-8GA	.438-.563	.281	.531-.594	.103-.115	3050	1805	2550
3/8"	C6LT-R12-4G	.125-.375	.422	.828-.922	.186-.202	6825	4020	6500
	C6LT-R12-6G	.250-.500	.422	.828-.922	.186-.202	6825	4020	6500
	C6LT-R12-8G	.375-.625	.422	.828-.922	.186-.202	6825	4020	6500
	C6LT-R12-10G	.500-.750	.422	.828-.922	.186-.202	6825	4020	6500

*Grip range and hole size calculated using a 2LC collar

Aluminum Pin

DIAMETER	PART NO.	GRIP RANGE	MAX HOLE SIZE	[B] HEAD DIA	[C] HEAD HEIGHT	MIN. SHEAR (LBF)	MIN. CLAMP (LBF)	MIN. TENSILE (LBF)
Round Head								
1/4"	C6LB-C8-4	.188-.313	.281	.713-.787	.136-.152	1875	950	1800
3/8"	C6LB-C12-6	.250-.500	.422	.713-.787	.223-.248	4200	2200	4200
	C6LB-C12-8	.375-.625	.422	.713-.787	.223-.248	4200	2200	4200
	C6LB-C12-10	.500-.750	.422	.713-.787	.223-.248	4200	2200	4200
	C6LB-C12-12	.625-.875	.422	.713-.787	.223-.248	4200	2200	4200

NOTE: Part numbers listed reflect typical stock. Additional Head Styles, material, diameter and grips may be available. All parts may be subject to minimum order.

C6L[®] Data and Dimensions

Steel Pin - Zinc Plated - Stainless Steel Cap

DIAMETER	PART NO.	GRIP RANGE	MAX HOLE SIZE	[B] HEAD DIA (MAX)	[C] HEAD HEIGHT (MAX)	MIN. SHEAR (LBF)	MIN. CLAMP (LBF)	MIN. TENSILE (LBF)
Truss Head								
1/4"	C6LTC-R8-3G	.125-.250	.281	.610	.165	3050	1805	2550
	C6LTC-R8-4G	.188-.313	.281	.610	.165	3050	1805	2550
	C6LTC-R8-5G	.250-.375	.281	.610	.165	3050	1805	2550
	C6LTC-R8-6G	.313-.438	.281	.610	.165	3050	1805	2550
	C6LTC-R8-7G	.375-.500	.281	.610	.165	3050	1805	2550
	C6LTC-R8-8G	.438-.563	.281	.610	.165	3050	1805	2550
	C6LTC-R8-9G	.500-.625	.281	.610	.165	3050	1805	2550
3/8"	C6LTC-R12-4G	.125-.375	.422	.860	.210	6825	4020	5625
	C6LTC-R12-6G	.250-.500	.422	.860	.210	6825	4020	5625
	C6LTC-R12-8G	.375-.625	.422	.860	.210	6825	4020	5625
	C6LTC-R12-10G	.500-.750	.422	.860	.210	6825	4020	5625
	C6LTC-R12-12G	.625-.875	.422	.860	.210	6825	4020	5625
	C6LTC-R12-14G	.750-1.000	.422	.860	.210	6825	4020	5625

Stainless Steel Pin

DIAMETER	PART NO.	GRIP RANGE	MAX HOLE SIZE	[B] HEAD DIA	[C] HEAD HEIGHT	MIN. SHEAR (LBF)	MIN. CLAMP (LBF)	MIN. TENSILE (LBF)
Rivet Head - Polished								
3/16"	C98LT-U6-3BR	.125-.250	.219	.446-.492	.090-.106	2000	1025	1455
	C98LT-U6-5BR	.250-.375	.219	.446-.492	.090-.106	2000	1025	1455
	C98LT-U6-6BR	.313-.438	.219	.446-.492	.090-.106	2000	1025	1455
	C98LT-U6-7BR	.375-.500	.219	.446-.492	.090-.106	2000	1025	1455
	C98LT-U6-9BR	.500-.625	.219	.446-.492	.090-.106	2000	1025	1455
	C98LT-U6-10BR	.563-.688	.219	.446-.492	.090-.106	2000	1025	1455
	C98LT-U6-11BR	.625-.750	.219	.446-.492	.090-.106	2000	1025	1455
	C98LT-U6-12BR	.688-.813	.219	.446-.492	.090-.106	2000	1025	1455
Round Head								
1/4"	C6LB-U8-3	.125-.250	.281	.475-.525	.136-.152	3550	1805	2750
	C6LB-U8-4	.188-.313	.281	.475-.525	.136-.152	3550	1805	2750
	C6LB-U8-5	.250-.375	.281	.475-.525	.136-.152	3550	1805	2750
	C6LB-U8-6	.313-.438	.281	.475-.525	.136-.152	3550	1805	2750
	C6LB-U8-8	.438-.563	.281	.475-.525	.136-.152	3550	1805	2750
	C6LB-U8-9	.500-.625	.281	.475-.525	.136-.152	3550	1805	2750
3/8"	C6LB-U12-6	.250-.500	.422	.713-.787	.223-.248	7950	4020	6100
	C6LB-U12-8	.375-.625	.422	.713-.787	.223-.248	7950	4020	6100
	C6LB-U12-10	.500-.750	.422	.713-.787	.223-.248	7950	4020	6100
Truss Head								
3/8"	C6LT-U12-4	.125-.375	.422	.828-.922	.186-.202	7950	4020	6100
	C6LT-U12-6	.250-.500	.422	.828-.922	.186-.202	7950	4020	6100
	C6LT-U12-8	.375-.625	.422	.828-.922	.186-.202	7950	4020	6100
	C6LT-U12-10	.500-.750	.422	.828-.922	.186-.202	7950	4020	6100

C6L® Data and Tooling

Tab-Lok™

The optional Tab-Lok feature makes sure the collar stays on the pin, before installation, in overhead and down slanted pin placements.

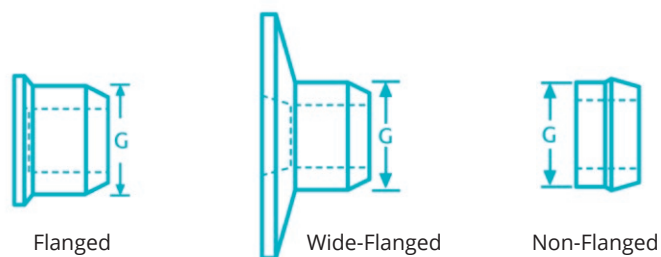

Installation Tooling

DIAMETER	TOOL	NOSE ASSEMBLY	TYPE
3/16"	244X	99-2555-HD	Pneudraulic
	256	99-2558	Pneudraulic
	2025*	99-3003**	Pneudraulic
	2480	99-3003**/99-2555-HD	Hydraulic
	2581	99-2558	Hydraulic
	BV4500-118	99-2555	Battery
1/4"	244X	99-3417	Pneudraulic
	256	99-2564	Pneudraulic
	2025*	99-3006**	Pneudraulic
	2480	99-3006**/99-3417	Hydraulic
	2581	99-2564	Hydraulic
	BV4500-118	99-3417	Battery
5/16"	256	99-99-245	Pneudraulic
	2581	99-99-245	Hydraulic
3/8"	256	99-100-245	Pneudraulic
	2581	99-100-245	Hydraulic

* Model 2025 is not recommended for high volume installation of stainless steel fasteners.

** When using tapered bore anvils, use visual inspection data for tapered bore anvil tooling.



Collars

STEEL, ZINC PLATED

DIAMETER	PART NO.	WIDTH (G)
Non-Flanged		
3/16"	2LC-R6G	.304-.311
1/4"	2LC-R8G	.402-.409
5/16"	2LC-R10G	.485-.494
3/8"	2LC-R12G	.590-.600
Flanged		
3/16"	3LC-2R6G	.304-.311
1/4"	3LC-2R8G	.402-.409
5/16"	3LC-2R10G	.498-.507
3/8"	3LC-2R12G	.599-.610
Wide-Flanged		
1/4"	3LCW-2R8G	.400-.409

ALUMINUM

DIAMETER	PART NO.	WIDTH (G)
Non-Flanged		
3/16"	2LC-F6	.304-.311
1/4"	2LC-F8	.402-.409
5/16"	2LC-F10	.499-.507
3/8"	2LC-F12	.590-.600
Flanged		
1/4"	3LC-F8	.402-.409
5/16"	3LC-F10	.498-.507
3/8"	3LC-F12	.599-.610

STAINLESS STEEL

DIAMETER	PART NO.	WIDTH (G)
Non-Flanged		
3/16"	2LC-2CU6	.304-.311
1/4"	2LC-2CU8	.402-.409
3/8"	2LC-2CU12	.590-.600
Flanged		
3/16"	3LC-2CU6	.304-.311
1/4"	3LC-2CU8	.402-.409
3/8"	3LC-2CU12	.599-.610

Magna-Grip®

Offering a Wide Grip Range and Uniform Installed Values

In applications where a wide grip range is required and a flush pin break to the collar is beneficial, Huck Magna-Grip® is the ideal fastener for the job. In fact, Magna-Grip's wide grip range can replace up to 4 traditional HuckBolts.

Like all Huck engineered fasteners, Magna-Grip offers the highest level of vibration resistance possible. Magna-Grip installs reliably and consistently provides high, uniform installed values.

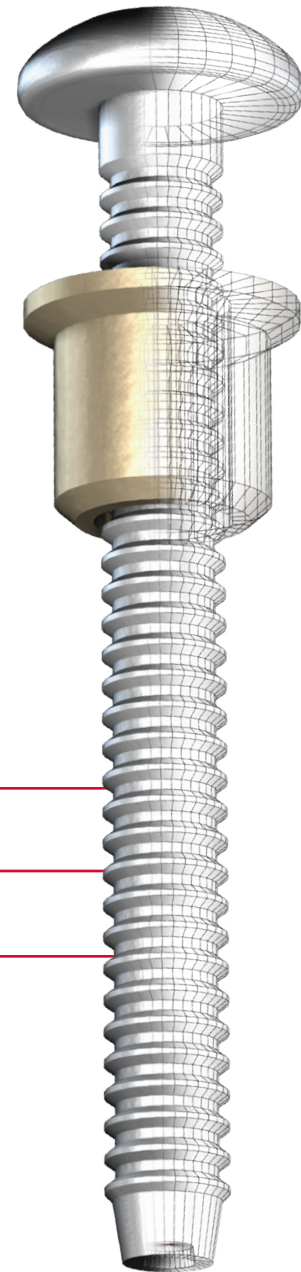

Available Sizes 3/16", 1/4", 5/16", 3/8"

Materials Steel, Aluminum

Headstyles Button, Truss, Broad Truss, 90° Flush, 98T

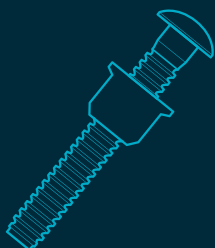

- ✓ Unmatched installation speed
- ✓ Low overall installed cost
- ✓ Vibration resistance
- ✓ Flush-breaking pin
- ✓ Eliminates need for secondary operations
- ✓ No special training or skills required for operators

Secure, Fast Installation

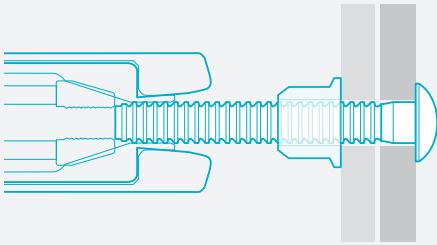

Insert fastener through a prepared hole. The precision collar is placed over the other end.

1

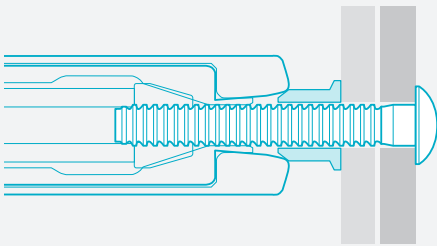

The Huck installation tool is applied and engages the pin. When the tool is activated, it pulls the pin in a straight line while pushing down on the collar.

2

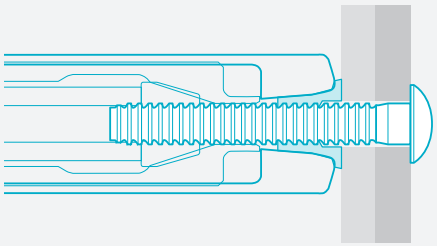

The tool moves forward over the collar, molding the collar material into the grooves of the pin. This process, called swaging, causes a precise stretching of the pin and collar, developing the fastener's clamping force.

3

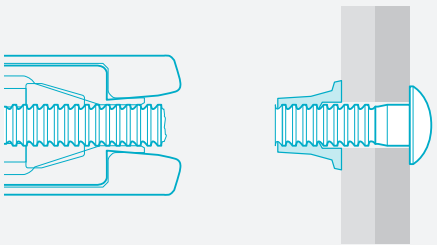

When swaging is complete the pintail is automatically tensioned off, flush with the end of the collar. The tool then pushes off from the collar. The result is a permanent, mechanically locked fastener

4

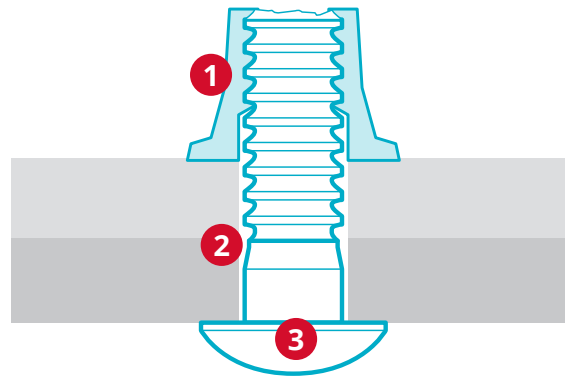

- 1** Flush-breaking, lock-groove design provides a wide grip range to reduce inventory requirements.
- 2** Collar material swaged into the annular pin grooves forms a permanent, vibration-proof connection that promotes increased customer satisfaction and reduced warranty claims.
- 3** Hole preparation isn't critical. Built-in system values yield high, consistent clamp loads and gap removal.



Magna-Grip® Data and Dimensions

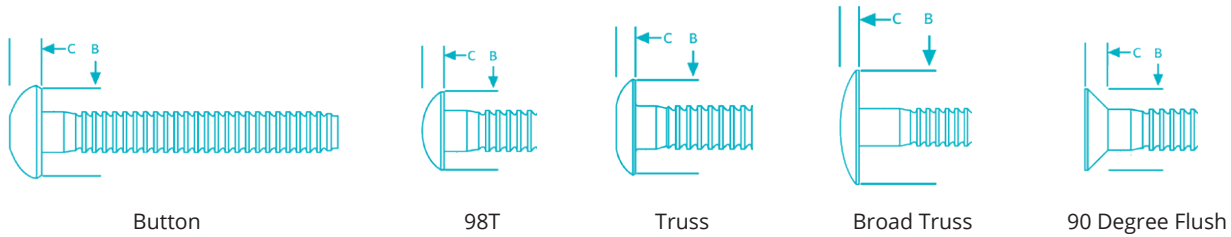

Steel Pin - Zinc Plated

DIAMETER	PART NO.	GRIP RANGE	MAX HOLE SIZE	[B] HEAD DIA	[C] HEAD HEIGHT	MIN. SHEAR (LBF)	MIN. CLAMP (LBF)	MIN. TENSILE (LBF)
Button Head								
3/16"	MGPB-R6-10G	.062-.625	.219	.360-.390	.111-.127	1725	1025	1650
	MGPB-R6-20G	.312-1.250	.219	.360-.390	.111-.127	1725	1025	1650
1/4"	MGPB-R8-10G	.125-.625	.281	.480-.520	.135-.155	2200	1350	2950
	MGPB-R8-20G	.312-1.250	.281	.480-.520	.135-.155	2200	1350	2950
5/16"	MGPB-R10-12G	.125-.750	.359	.600-.650	.180-.205	3000	2300	4400
	MGPB-R10-22G	.625-1.375	.359	.600-.650	.180-.205	3000	2300	4400
3/8"	MGPB-R12-14G	.188-.875	.422	.720-.780	.220-.250	4200	3200	6000
	MGPB-R12-26G	.812-1.625	.422	.720-.780	.220-.250	4200	3200	6000
98T Head								
3/16"	MGP98T-R6-10G	.062-.625	.219	.467-.488	.098-.110	1725	1025	1650
	MGP98T-R6-10GP	.062-.625	.219	.467-.488	.098-.110	1725	1025	1650
	MGP98T-R6-20G	.312-1.250	.219	.467-.488	.098-.110	1725	1025	1650
Truss Head								
1/4"	MGPT-R8-10G	.125-.625	.281	.530-.595	.115-.135	2200	1350	2950
	MGPT-R8-10GP	.125-.625	.281	.530-.595	.115-.135	2200	1350	2950
	MGPT-R8-20G	.312-1.250	.281	.530-.595	.115-.135	2200	1350	2950
5/16"	MGPT-R10-12G	.125-.750	.359	.700-.795	.125-.175	3000	2300	4400
3/8"	MGPT-R12-14G	.188-.875	.422	.830-.920	.150-.215	4200	3200	6000
Broad Truss Head								
1/4"	MGP30-R8-10G	.125-.625	.281	.900-.970	.135-.165	2200	1350	2950
	MGP30-R8-24G	.562-1.500	.281	.900-.970	.135-.165	2200	1350	2950
3/8"	MGP30-R12-24G	.688-1.500	.422	1.180-1.255	.185-.215	4200	3200	6000
	MGP30-R12-32G	1.188-2.000	.422	1.180-1.255	.185-.215	4200	3200	6000
90° Flush Head								
3/16"	MGP90-R6-10G	.062-.625	.219	.325-.360	.090-.105	1725	1025	1650
1/4"	MGP90-R8-10G	.125-.625	.281	.435-.475	.115-.130	2200	1350	2950

Steel Pin - Zinc Plated - Stainless Steel Cap

Truss Head								
1/4"	MGPTC-R8-10G	.125-.625	.281	.620 max	.165 max	2200	1350	2950
3/8"	MGPTC-R12-14G	.188-.875	.422	.860 max	.210 max	4200	3200	6000

Aluminum Pins

Button Head								
3/16"	MGPB-E6-10	.062-.625	.219	.360-.390	.111-.127	750	550	900
1/4"	MGPB-E8-10	.125-.625	.281	.480-.520	.135-.155	1200	950	1620
	MGPB-E8-20	.312-1.250	.281	.480-.520	.135-.155	1200	950	1620
5/16"	MGPB-E10-12	.125-.750	.359	.600-.650	.180-.205	2200	1600	2500
3/8"	MGPB-E12-14	.188-.875	.422	.720-.780	.220-.250	3000	2400	4000
98T Head								
3/16"	MGP98T-E6-10	.062-.625	.219	.467-.488	.098-.110	750	550	900
	MGP98T-E6-20	.312-1.250	.219	.467-.488	.098-.110	750	550	900
Truss Head								
1/4"	MGPT-E8-10	.125-.625	.281	.530-.595	.115-.135	1200	950	1620
Broad Truss Head								
3/8"	MGP30-E12-24	.688-1.500	.422	1.180-1.255	.185-.215	3000	2400	4000
90° Flush Head								
3/16"	MGP90-E6-10	.062-.625	.219	.325-.360	.090-.105	750	550	900
1/4"	MGP90-E8-10	.125-.625	.281	.435-.475	.115-.130	1200	950	1620

NOTE: Part numbers listed reflect typical stock. Additional Head Styles, material, diameter and grips may be available. All parts may be subject to minimum order.

Magna-Grip® Data and Tooling

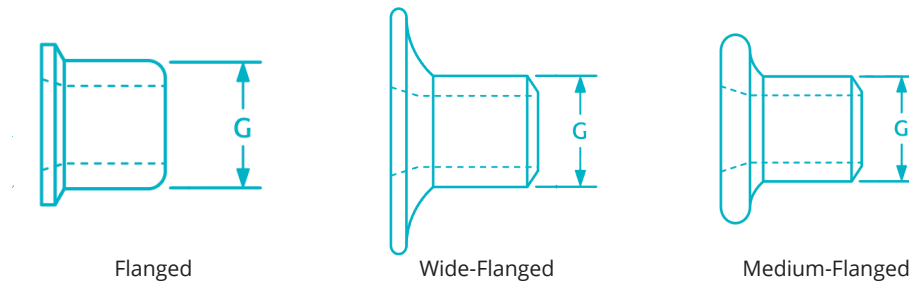

Collars

	DIAMETER	PART NO.	WIDTH(G)
Steel - Zinc Plated			
Flanged	3/16"	MGC-R6U	.305-.315
	1/4"	MGC-R8U	.395-.405
	5/16"	MGC-R10U	.500-.510
	3/8"	MGC-R12U	.600-.612
Medium Flange	3/16"	MGCS-R6U	.305-.315
Wide Flange	3/16"	MGCW-R6U	.305-.315
	1/4"	MGCW-R8U	.395-.405
Aluminum			
Flanged	3/16"	MGC-F6	.305-.315
	1/4"	MGC-F8	.395-.405
	5/16"	MGC-F10	.500-.510
	3/8"	MGC-F12	.600-.612
Wide Flange	3/16"	MGCW-F6	.305-.315

Tab-Lok™

The optional Tab-Lok feature makes sure the collar stays on the pin, before installation, in overhead and down slanted pin placements.

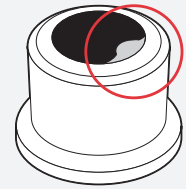

Installation Tooling

DIAMETER	TOOL	NOSE ASSEMBLY	TYPE
3/16"	2025	99-3201	Pneudraulic
	256	99-3206	Pneudraulic
	2480	99-3201	Hydraulic
	2581	99-3206	Hydraulic
	BV4500-118	99-3201	Battery
1/4"	2025	99-3204	Pneudraulic
	256	99-3207	Pneudraulic
	2480	99-3204	Hydraulic
	2581	99-3207	Hydraulic
	BV4500-118	99-3204	Battery
5/16"	256	99-1439	Pneudraulic
	2581	99-1439	Pneudraulic
	2600	99-3217	Pneudraulic
3/8"	256	99-1440	Pneudraulic
	2581	99-1440	Hydraulic
	2600	99-3220	Hydraulic

Hucktainer®

Two-Piece Specialty Fastener for Fiberglass Reinforced Plywood Panels

The Hucktainer® specialty fastener installs with a consistent pressure, reducing the potential for crushing or crazing FRP panels and metal-clad applications. Each features a heavy zinc plating that resists corrosion, and an integral seal that helps keep the elements and other contaminants from invading the joint. Unlike threaded fasteners, Hucktainer is never over-torqued or under-torqued. Consistent clamp and fast, foolproof installation is what you'll get every time with Hucktainer.

Designed specifically for truck trailers, truck bodies, cargo containers, and other structures fabricated from fiberglass reinforced plywood, Hucktainer fasteners provide the consistent clamp and fast, foolproof installation required for maximum product quality and productivity.

Available Sizes	3/8"
Materials	Steel
Headstyles	Standard, Medium-Bearing Encapsulated, Wide Bearing Encapsulated

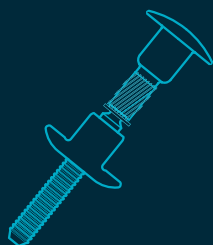
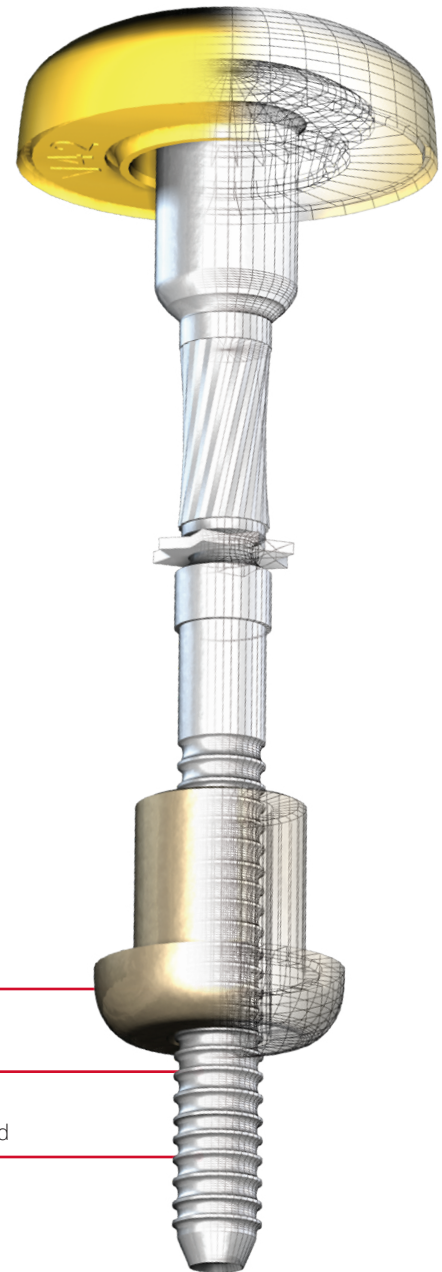

- ✓ Fast, quiet, foolproof installation
- ✓ Corrosion Resistant
- ✓ Spiral lock system, breakaway pintail, and smooth bore sleeve
- ✓ Resistant to over or under-torqued
- ✓ Tamper-resistant
- ✓ Custom coloring for encapsulations available
- ✓ Shorter grips available for today's thin metal-clad panels
- ✓ RoHS compliant

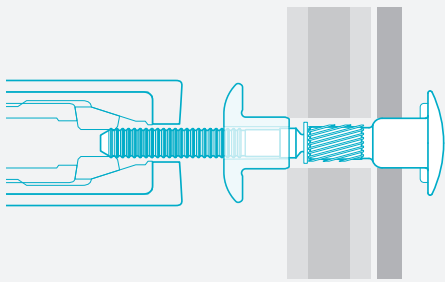

Insert pin and sleeve into prepared hole.

1

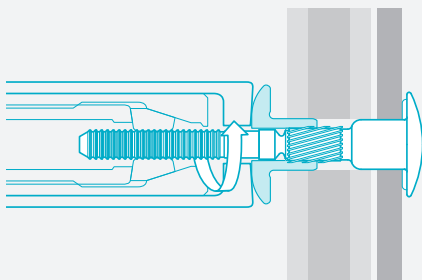

The installation tool is applied to the pintail. When the tool is activated, the sleeve is forced onto the spiral lock of the pin. The rotating action of the nose assembly allows the sleeve to turn freely.

2

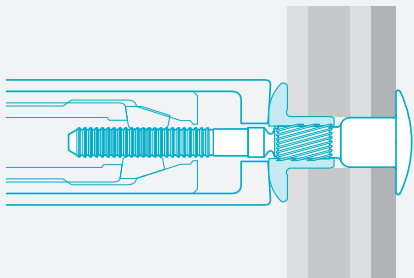

The sleeve is fully engaged on the pin and locks onto the pin's splines to clamp the material tightly together.

3

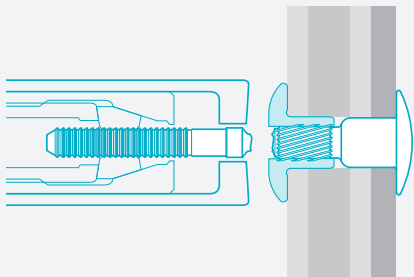

Continued pull of the tool causes the pintail to break away, which completes the installation cycle.

4

Weather-Resistant Seal

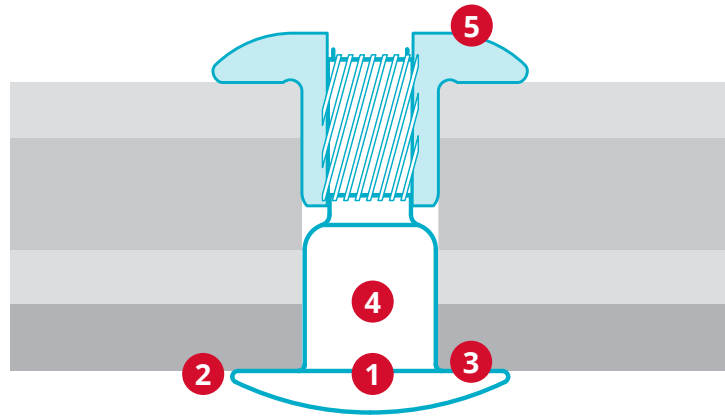

- 1** Lower profile head design saves cargo space.
- 2** Heads may be plastic-encapsulated for maximum corrosion-resistance; UV-resistant head capsules are colorfast and won't fade.
- 3** Integral weather-resistant seal provides protection from the elements.
- 4** Heavy-zinc plating protects against corrosion and preserves good looks.
- 5** One sleeve fits all pins; no need to mix and match.



Hucktainer® Data and Dimensions

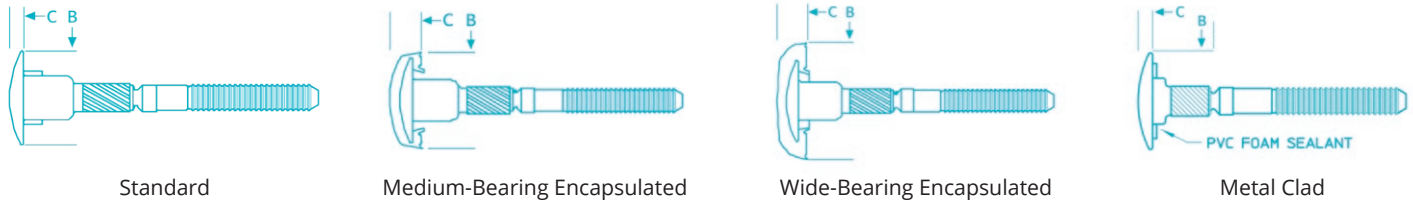

Steel Pin - Zinc Plated

DIAMETER	PART NO.	GRIP RANGE	HOLE SIZE	[B] HEAD DIA (MAX)	[C] HEAD HEIGHT (MAX)	TYPICAL CLAMP (LBF)	MIN. TENSILE (LBF)	TYPICAL TENSILE (LBF)	
								MIN GRIP	MAX GRIP
Standard Head									
3/8"	HLPP-R12-10PL	.562-.687	.405-.421	.845	.160	700	800	1800	1200
	HLPP-R12-11PL	.625-.750	.405-.421	.845	.160	700	800	1800	1200
	HLPP-R12-12PL	.687-.812	.405-.421	.845	.160	700	800	1800	1200
	HLPP-R12-13PL	.750-.875	.405-.421	.845	.160	700	800	1800	1200
	HLPP-R12-14PL	.812-.937	.405-.421	.845	.160	700	800	1800	1200
	HLPP-R12-15PL	.875-1.000	.405-.421	.845	.160	700	800	1800	1200
	HLPP-R12-16PL	.937-1.062	.405-.421	.845	.160	700	800	1800	1200
	HLPP-R12-17PL	1.000-1.125	.405-.421	.845	.160	700	800	1800	1200
	HLPP-R12-18PL	1.062-1.187	.405-.421	.845	.160	700	800	1800	1200
HLPP-R12-19PL	1.125-1.250	.405-.421	.845	.160	700	800	1800	1200	
HLPP-R12-20PL	1.187-1.312	.405-.421	.845	.160	700	800	1800	1200	
Medium Bearing Encapsulated Head									
3/8"	HLPM*-R12-9PL***	.500-.625	.405-.421	.960	.325	700	800	1800	1200
	HLPM*-R12-10PL	.562-.687	.405-.421	.960	.325	700	800	1800	1200
	HLPM*-R12-11PL	.625-.750	.405-.421	.960	.325	700	800	1800	1200
	HLPM*-R12-12PL	.687-.812	.405-.421	.960	.325	700	800	1800	1200
	HLPM*-R12-13PL	.750-.875	.405-.421	.960	.325	700	800	1800	1200
	HLPM*-R12-14PL	.812-.937	.405-.421	.960	.325	700	800	1800	1200
	HLPM*-R12-15PL	.875-1.000	.405-.421	.960	.325	700	800	1800	1200
	HLPM*-R12-16PL	.937-1.062	.405-.421	.960	.325	700	800	1800	1200
	HLPM*-R12-17PL	1.000-1.125	.405-.421	.960	.325	700	800	1800	1200
HLPM*-R12-18PL	1.062-1.187	.405-.421	.960	.325	700	800	1800	1200	
HLPM*-R12-19PL	1.125-1.250	.405-.421	.960	.325	700	800	1800	1200	
Wide Bearing Encapsulated Head									
3/8"	HLPE*-R12-9PL***	.500-.625	.405-.421	1.220	.325	700	800	1800	1200
	HLPE*-R12-10PL	.562-.687	.405-.421	1.220	.325	700	800	1800	1200
	HLPE*-R12-11PL	.625-.750	.405-.421	1.220	.325	700	800	1800	1200
	HLPE*-R12-12PL	.687-.812	.405-.421	1.220	.325	700	800	1800	1200
	HLPE*-R12-13PL	.750-.875	.405-.421	1.220	.325	700	800	1800	1200
	HLPE*-R12-14PL	.812-.937	.405-.421	1.220	.325	700	800	1800	1200
	HLPE*-R12-15PL	.875-1.000	.405-.421	1.220	.325	700	800	1800	1200
	HLPE*-R12-16PL	.937-1.062	.405-.421	1.220	.325	700	800	1800	1200
	HLPE*-R12-17PL	1.000-1.125	.405-.421	1.220	.325	700	800	1800	1200
HLPE*-R12-18PL	1.062-1.187	.405-.421	1.220	.325	700	800	1800	1200	
HLPE*-R12-19PL	1.125-1.250	.405-.421	1.220	.325	700	800	1800	1200	
Metal Clad									
3/8"	HLP MC-R12-4PL**	.187-.312	.405-.421	.845	.145	700	600	1600	1000
	HLP MC-R12-5PL	.250-.375	.405-.421	.845	.145	700	600	1600	1000
	HLP MC-R12-6PL	.312-.437	.405-.421	.845	.145	700	600	1600	1000
	HLP MC-R12-7PL	.375-.500	.405-.421	.845	.145	700	600	1600	1000
	HLP MC-R12-8PL	.437-.562	.405-.421	.845	.145	700	600	1600	1000
	HLP MC-R12-9PL	.500-.625	.405-.421	.845	.145	700	600	1600	1000

*Available standard encapsulated head colors: G - Grey | RY - Ryder Yellow | W - White | HY - Hertz Yellow

** Only available with encapsulated head *** Not available with encapsulated head

Encapsulated fasteners also available in metal clad

NOTE: Part numbers listed reflect typical stock. Additional Head Styles, material, diameter and grips may be available. All parts may be subject to minimum order.

Hucktainer® Data and Tooling

Materials and Finishes

PART	MATERIAL	FINISH
Metal-Clad HLP		
Pin	Steel	Zinc/Clear Chromate
Sleeve	Steel	Zinc/Black Chromate
Standard HLP		
Pin	Steel	Zinc/Clear Chromate
Sleeve	Steel	Zinc/Gold Chromate

Sleeves - Zinc Plated



Clearance Sleeve
HLPSC-R12



Medium Bearing Sleeve
HLPSC-R12



Large Bearing Sleeve
HLPSC-R12

Pin Locks

All HLP's come with a pin lock, which keeps the pin in the hole while placing a sleeve over the pintail and prevents pin from vibrating out of the hole as neighboring fasteners are installed.

Pin locks are color coded to identify specific grip lengths of loose fasteners from a distance.

Color coded pin locks are only available on HLMC products. All standard HLP pins have white pin locks.

HLMC Pin Lock Colors

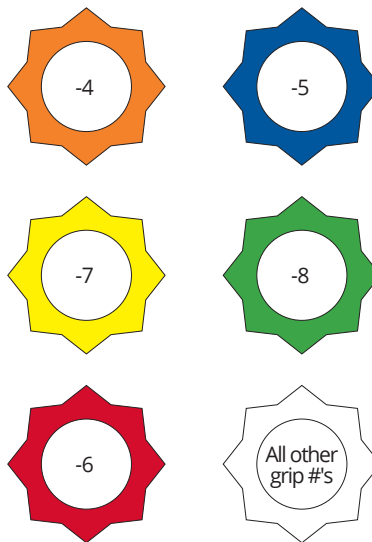

Installation Tooling

DIAMETER	TOOL	NOSE ASSEMBLY	TYPE
3/8"	2025	99-3464	Pneudraulic
	256	99-3438	Pneudraulic
	2480	99-3464	Hydraulic
	2581	99-3438	Hydraulic
	BV4500-118*	99-3464	Battery

*Use Adapter 131748

Huck® Structural Blind Rivets

When High Performance and Holding Power are Critical

Huck Structural Blind Rivets are Howmet's answer to loosening and vibration challenges. And it's the reason they are the world's strongest, most reliable, most consistent blind fastening solution available.

In fatigue tests, Huck Structural Blind Rivets outlast alternative forms of fastening. Engineered with a unique locking design, many of these fasteners create an internal lock during installation that virtually eliminates pin push-out by mechanically locking the pin to the sleeve. Each locks permanently into place with little effort. Simple, visual inspections ensure joint integrity.

In applications where vibration resistance, reliability, and strong hold are critical, no fastening system is more dependable than Huck.

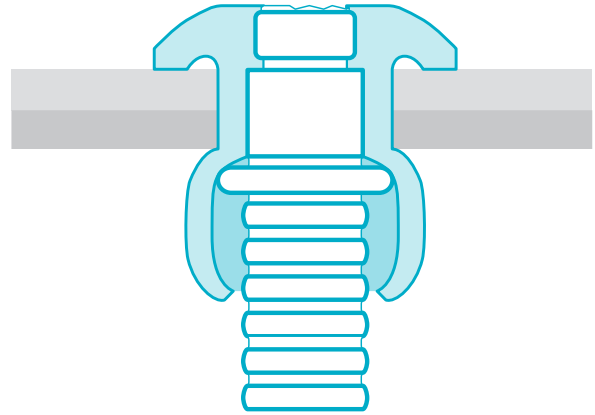

HuckLok's proprietary solid circle lock ensures maximum strength and vibration resistance. Shear ring at the sheet line provides a consistent clamp.

Sheet-Line Bulb Comparison

Even in minimum-grip applications, Huck fasteners outperform the competition. They're engineered to form a bulb directly on the sheet line, precisely where it's needed, to prevent pull-through.



Auto-Bulb®

Bulb forms directly on sheet line.



The Competition

Bulb forms irregularly above sheet line resulting in lower installed values.

A Strong Family of Fasteners

When only one side of the joint material is accessible, performance-engineered Huck blind fasteners are the smart choice.



Magna-Lok®

Hole-filling fastener with excellent gap pull-out and moisture resistance. Solid circle lock creates internal lock that virtually eliminates pin push-out.



Magna-Bulb®

Unique bulbing fastener with high shear strength offers a broader bearing surface for high pull-out strength in thin materials and/or oversized holes



HuckLok®

Wide 1/4" grip range, double-locking action clamps assembly from both sides for maximum joint integrity.



Auto-Bulb®

Features a tapered lead-in point for automated, high-speed assemblies. Forms a bulb directly on the sheet line, preventing pull-through. Available in stainless steel.



Magna-Tite®

Has water-resistant sealant for oversize holes and repairs. Large blind-side footprint for use in thin or low-strength materials.



BOM®

Blind, Oversize, Mechanically locked fasteners. Unique push-and-pull installation design for ultimate locking strength from blind-side install.



FloorTight®

Self-countersinking design for consistent installations in plywood and plymetal vehicle floor applications.

Magna-Lok®

The Hole-Filling Fastener with Mechanical Circle Lock and Wide Grip Range

The 360° solid-circle lock. It's Howmet Fastening System's answer to loosening and vibration challenges. It's the reason Magna-Lok® is the world's strongest, most reliable, most consistent blind fastening solution available. The unique locking design creates an internal lock during installation that virtually eliminates pin pushout by mechanically locking the pin to the sleeve. So Magna-Lok fasteners reliably lock flush into place. Permanently.

In lab shear fatigue tests, steel Magna-Lok fasteners substantially outlasted competitors' products. We have engineered industry-leading strength and durability into Magna-Lok with a mechanical circle-lock design that gives this structural blind rivet a tough, long-lasting joint with a tight, weather-resistant seal. This shield blocks out water and salt, ensuring a long, reliable life.

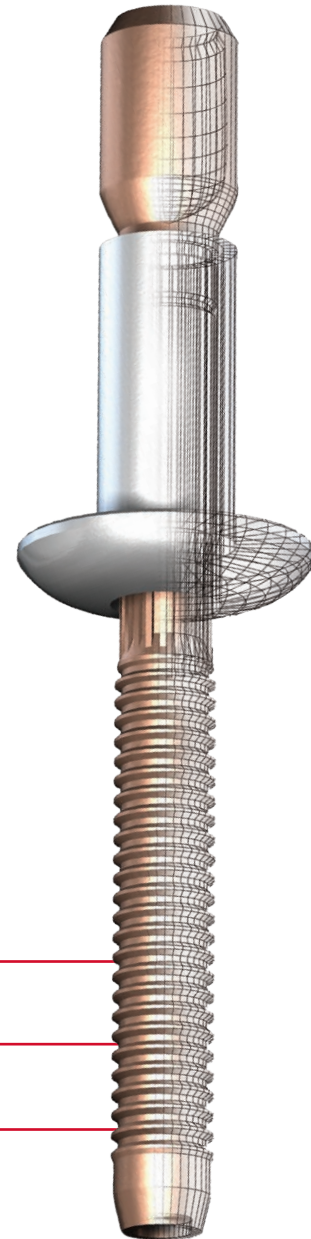

Available Sizes 3/16", 1/4", 3/8", 1/2"

Materials Steel, Aluminum, Stainless Steel

Headstyles Protruding, Truss, 100° Flush

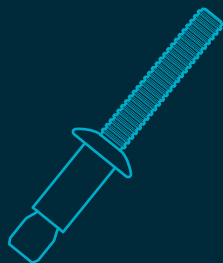

- ✓ Unmatched installation speed
- ✓ Low overall installed cost
- ✓ Vibration resistance
- ✓ Weather-resistant seal
- ✓ Quiet non-torque tools
- ✓ No repetitive stress injuries
- ✓ Eliminates need for secondary operations
- ✓ No special training or skills required for operators

Secure, Fast Installation

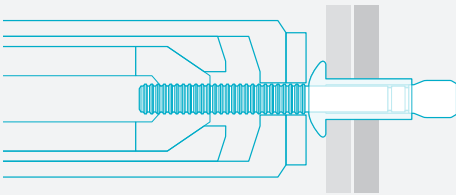

Insert the fastener into the hole and slip the installation tool over the pintail.

1

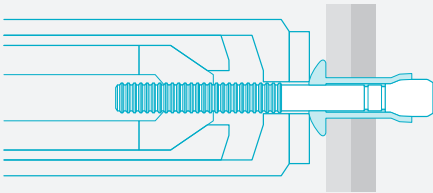

Press the trigger to initiate pulling action. As the tool pulls on the pintail, the pin (mandrel) expands the sleeve and begins drawing the work pieces together.

2

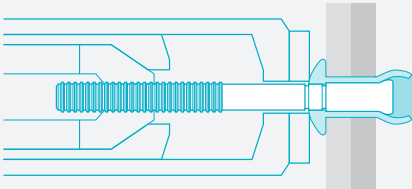

Continued pulling on the pintail draws the hollow pin head inside sleeve. The pin expands inside the sleeve and the work pieces, to completely fill the hole of the work pieces.

3

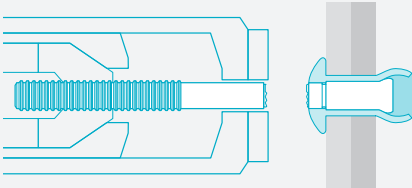

A solid circle lock between the pin and sleeve is formed just prior to the pin breaking flush with the sleeve head, completing the installation.

4

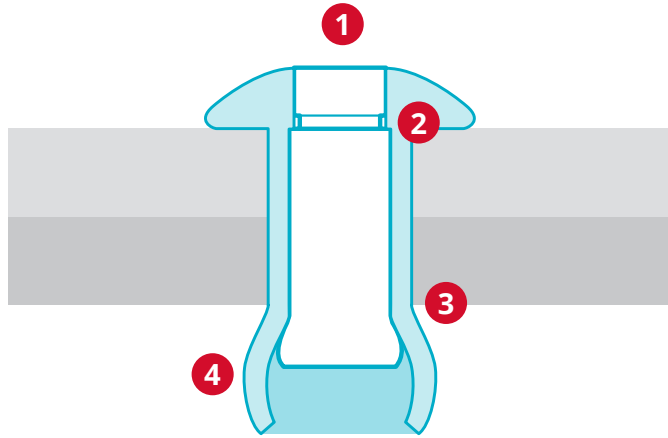

- 1** Flush pin break eliminates grinding and filling, leaving an even surface.
- 2** Unique, solid-circle lock ensures maximum strength and vibration resistance. The potential for pin push-out is virtually eliminated.
- 3** Excellent gap pull-out and high retained clamp.
- 4** Sleeve expands during installation to fill the hole and create a moisture-resistant joint.

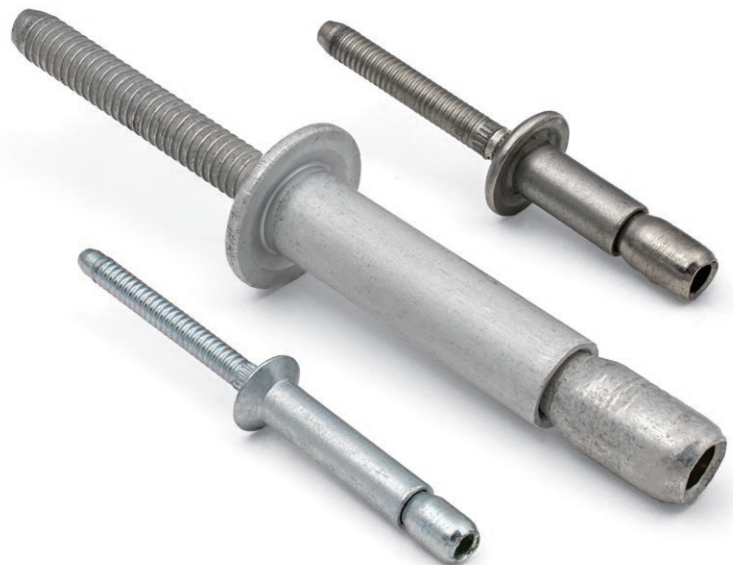

Magna-Lok[®] Data and Dimensions

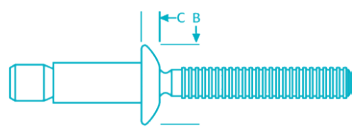

Protruding Head

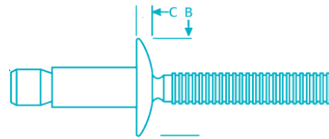

Truss Head

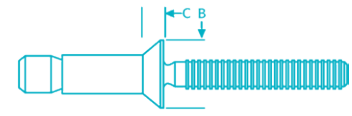

100° Flush Head

Steel Rivet/Steel Mandrel

DIAMETER	PART NO.	GRIP RANGE	HOLE SIZE	[B] HEAD DIA MAX	[C] HEAD HEIGHT MAX	MIN. SHEAR (LBF)	MIN. TENSILE (LBF)
Protruding Head							
3/16"	MGLP-R6-4	.062-.270	.191-.201	.385	.085	1300	1000
	MGLP-R6-7	.214-.437	.191-.201	.385	.085	1300	1000
	MGLP-R6-10	.455-.665	.191-.201	.385	.085	1300	1000
	MGLP-R6-E	.062-.437	.191-.201	.385	.085	1300	1000
1/4"	MGLP-R8-6	.080-.375	.261-.272	.530	.120	2500	1850
	MGLP-R8-7	.214-.437	.261-.272	.530	.120	2500	1850
	MGLP-R8-10	.350-.625	.261-.272	.530	.120	2500	1850
	MGLP-R8-14	.580-.875	.261-.272	.530	.120	2500	1850
	MGLP-R8-22	1.080-1.375	.261-.272	.530	.120	2500	1850
	MGLP-R8-E	.080-.625	.261-.272	.530	.120	2500	1850
	MGLP-R8-E12.6*	.245-.790	.261-.272	.530	.120	2500	1850
3/8"	MGLP-R12-12	.120-.625	.392-.408	.793	.175	6000	4000
1/2"	MGLP-R16-12	.160-.750	.531-.563	1.060	.240	10000	7000
Truss Head							
3/16"	MGLT-R6-4	.062-.270	.191-.201	.530	.095	1300	1000
	MGLT-R6-E	.062-.437	.191-.201	.530	.095	1300	1000
1/4"	MGLT-R8-6	.080-.375	.261-.272	.592	.120	2500	1850
100° Flush Head							
3/16"	MGL100-R6-6	.125-.331	.191-.201	.350	.080	1300	1000
	MGL100-R6-9	.305-.500	.191-.201	.350	.080	1300	1000
1/4"	MGL100-R8-8	.160-.475	.261-.272	.410	.090	2500	1850
	MGL100-R8-12	.415-.725	.261-.272	.410	.090	2500	1850

* Also available in 400 Stainless Steel

Aluminum Rivet/Aluminum Mandrel

Protruding Head							
3/16"	MGLP-B6-4	.062-.270	.191-.201	.385	.085	600	500
	MGLP-B6-7	.214-.437	.191-.201	.385	.085	600	500
	MGLP-B6-E	.062-.437	.191-.201	.385	.085	600	500
1/4"	MGLP-B8-6	.080-.375	.261-.272	.530	.120	1300	890
	MGLP-B8-10	.350-.625	.261-.272	.530	.120	1300	890
	MGLP-B8-E	.080-.625	.261-.272	.530	.120	1300	890
3/8"	MGLP-B12-12	.120-.625	.392-.408	.793	.175	3000	2100
1/2"	MGLP-B16-12	.160-.750	.531-.563	1.060	.240	5400	4100
Truss Head							
3/16"	MGLT-B6-4	.062-.270	.191-.201	.530	.095	600	500
	MGLT-B6-7	.214-.437	.191-.201	.530	.095	600	500
	MGLT-B6-E	.062-.437	.191-.201	.530	.095	600	500
100° Flush Head							
3/16"	MGL100-B6-6	.125-.331	.191-.201	.350	.080	600	500
	MGL100-B6-9	.305-.500	.191-.201	.350	.080	600	500
	MGL100-B6-12	.080-.375	.191-.201	.350	.080	600	500
	MGL100-B6-14	.080-.375	.191-.201	.350	.080	600	500
1/4"	MGL100-B8-8	.160-.475	.261-.272	.410	.090	1300	890
	MGL100-B8-12	.415-.725	.261-.272	.410	.090	1300	890

NOTE: Part numbers listed reflect typical stock. Additional Head Styles, material, diameter and grips may be available. All parts may be subject to minimum order.

Magna-Lok® Data and Tooling

Stainless Sleeve/Stainless Mandrel

DIAMETER	PART NO.	GRIP RANGE	HOLE SIZE	[B] HEAD DIA (MAX)	[C] HEAD HEIGHT (MAX)	MIN. SHEAR (LBF)	MIN. TENSILE (LBF)
Protruding Head							
3/16"	MGLP-U6-4	.062-.270	.191-.201	.392	.101	1300	950
	MGLP-U6-7	.214-.437	.191-.201	.392	.101	1300	950
	MGLP-U6-E	.062-.437	.191-.201	.392	.101	1300	950
1/4"	MGLP-U8-6	.080-.375	.261-.272	.530	.120	2350	1800
	MGLP-U8-7	.080-.437	.261-.272	.530	.120	2350	1800
	MGLP-U8-10	.350-.625	.261-.272	.530	.120	2350	1800
	MGLP-U8-E	.080-.625	.261-.272	.530	.120	2350	1800
100° Flush Head							
3/16"	MGL100-U6-6	.125-.331	.392-.408	.350	.080	1300	950
	MGL100-U6-9	.305-.500	.392-.408	.350	.080	1300	950
1/4"	MGL100-U8-8	.160-.475	.531-.563	.410	.090	2350	1800
	MGL100-U8-12	.415-.725	.531-.563	.410	.090	2350	1800

NOTE: Part numbers listed reflect typical stock. Additional Head Styles, material, diameter and grips may be available. All parts may be subject to minimum order.

Installation Tooling

DIAMETER	TOOL	NOSE ASSEMBLY	TYPE
3/16"	2024*	99-3303	Pneudraulic
	2480	99-3303	Hydraulic
	BV4500-118	99-3303	Battery
1/4"	2024*	99-3305	Pneudraulic
	2480	99-3305	Hydraulic
	BV4500-118	99-3305	Battery
3/8"	256	99-3318	Pneudraulic
	2581	99-3318	Hydraulic
1/2"	2583**	99-3330	Hydraulic
	2620 PT ***	99-3331	Hydraulic

*Preferred Tool. **Aluminum only. ***Steel only.

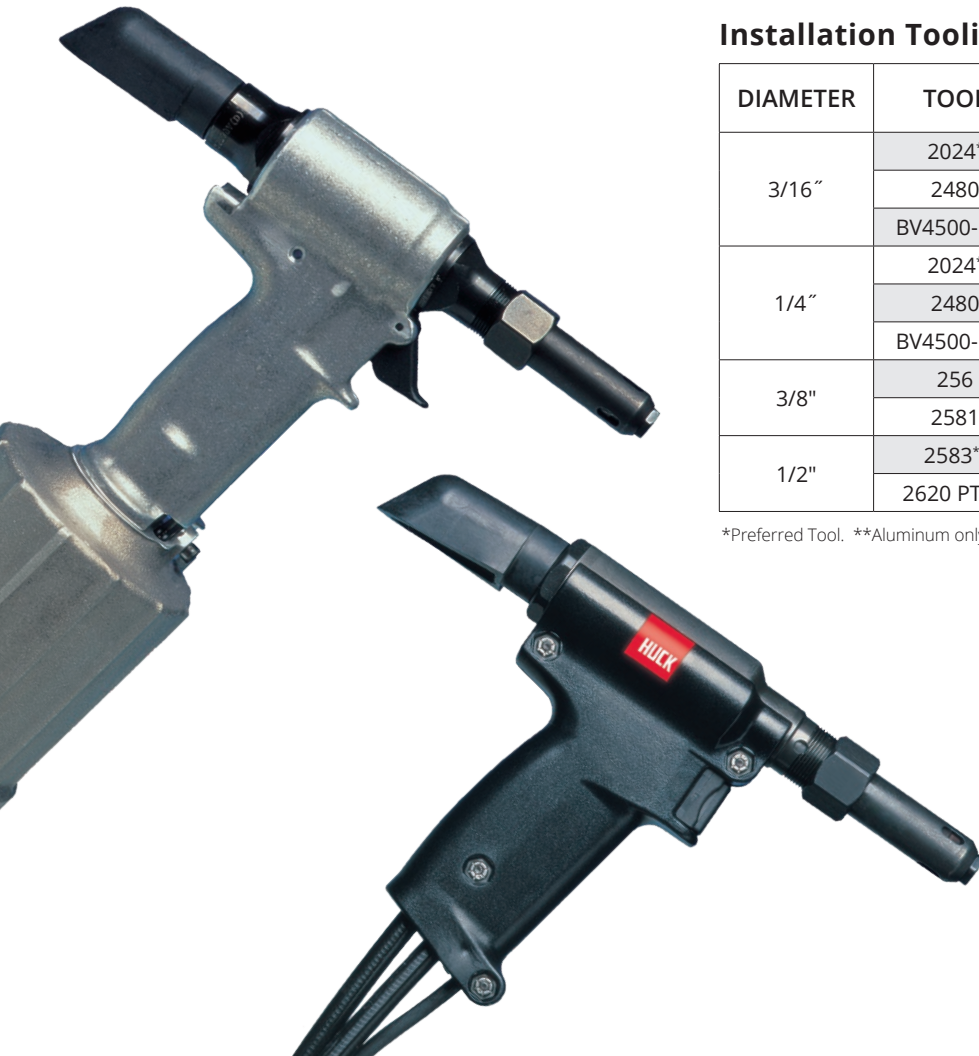

Magna-Bulb®

A Unique Bulbing Fastener with High Shear Strength

Huck Magna-Bulb® is a unique, clamp-type fastener offering high shear strength in specific applications. Its bulbing action during installation spreads the load over more surface area, supplying a stronger, longer-lasting connection, while offering superior blind side strength.

This increased bearing area makes Magna-Bulb ideal for pull-out resistance in thin materials, and oversized or misaligned holes. Positive, mechanical pin-retention ensures structural integrity no matter what the application.

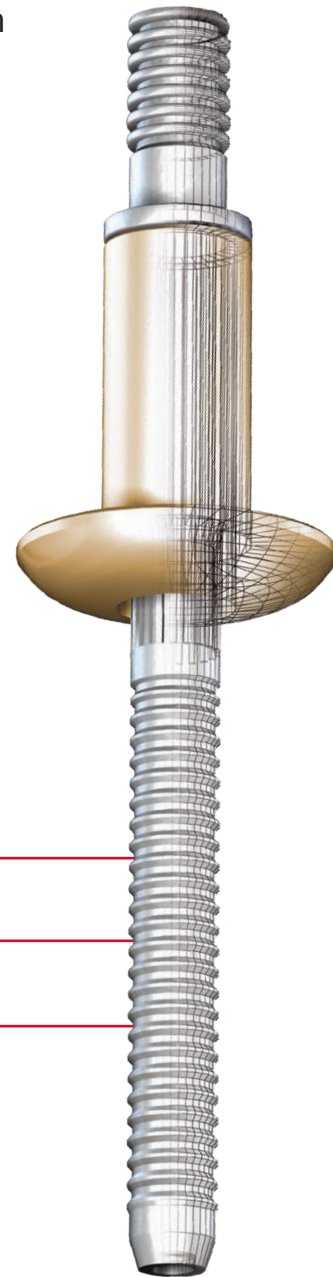

Available Sizes 3/16", 1/4", 5/16"

Materials Steel

Headstyles Protruding, Truss, 100° Oval Flush



- ✓ Unmatched installation speed
- ✓ Low overall installed cost
- ✓ Vibration resistance
- ✓ Weather-resistant seal
- ✓ Quiet non-torque tools
- ✓ No repetitive stress injuries
- ✓ Eliminates need for secondary operations
- ✓ No special training or skills required for operators

Secure, Fast Installation

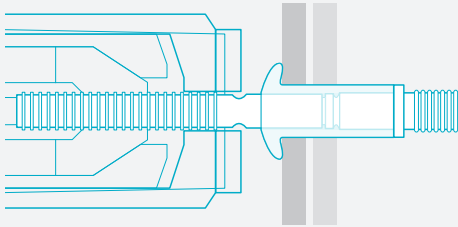

Insert the fastener into the hole and slip the installation tool over the pintail.

1

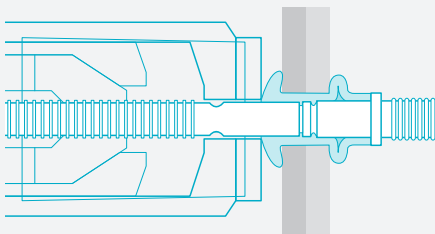

Press the trigger to initiate pulling action. As the tool pulls on the pintail, the pin (mandrel) expands the sleeve and begins drawing the work pieces together.

2

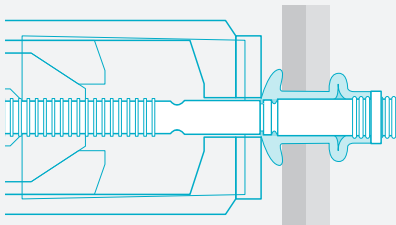

Press the trigger to initiate pulling action. As the tool pulls on the pintail, the pin (mandrel) expands the sleeve and begins drawing the work pieces together.

3

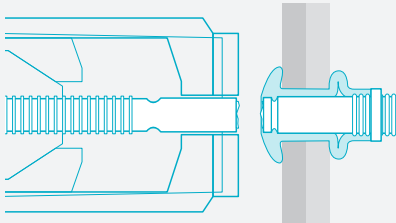

A solid circle lock between the pin and sleeve is formed just prior to the pin breaking flush with the sleeve head, completing the installation.

4

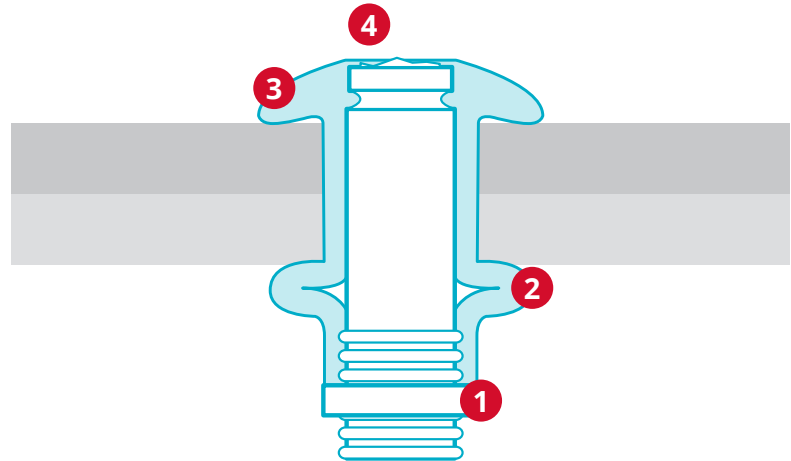

- 1** Shear ring design promotes bulb formation and grip adjustment for flush break throughout the grip range
- 2** The wide blind footprint (bulb) gives the fastener a broader bearing surface, spreading the load out for greater strength and high pull out resistance
- 3** Unique solid circle lock ensures maximum strength and resistance to vibration
- 4** Breaking flush throughout the entire grip range, the Magna-Bulb fastener eliminates costly cosmetic finish work. Simple visual inspection ensures that the fastener is installed correctly.



Magna-Bulb® Data and Tooling

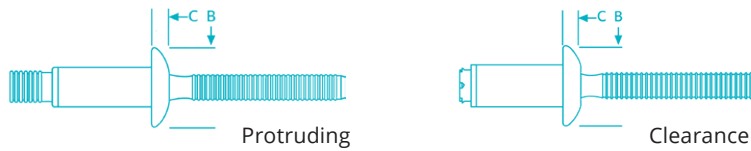

Steel Rivet/Steel Mandrel

DIAMETER	PART NO.	GRIP RANGE (IN)	GRIP RANGE (MM)	HOLE SIZE	[B] HEAD DIA (MAX)	[C] HEAD HEIGHT (MAX)	MIN. SHEAR (LBF)	MIN. TENSILE (LBF)	
Protruding Head									
3/16"	MBP-R6-M3	.087-.150	2.2-3.8	.191-.201	.395	.101	1950	1050	
	MBP-R6-M4	.126-.189	3.2-4.8	.191-.201	.395	.101	1950	1050	
	MBP-R6-M5	.165-.228	4.2-5.8	.191-.201	.395	.101	1950	1050	
	MBP-R6-M6	.205-.268	5.2-6.8	.191-.201	.395	.101	1950	1050	
	MBP-R6-M7	.244-.307	6.2-7.8	.191-.201	.395	.101	1950	1050	
	MBP-R6-M8	.283-.347	7.2-8.8	.191-.201	.395	.101	1950	1050	
1/4"	MBP-R8-M3	.110-.189	2.8-4.8	.261-.272	.530	.125	2700	1900	
	MBP-R8-M4	.150-.229	3.8-5.8	.261-.272	.530	.125	2760	1900	
	MBP-R8-M5	.189-.268	4.8-6.8	.261-.272	.530	.125	3000	1900	
	MBP-R8-M6	.229-.308	5.8-7.8	.261-.272	.530	.125	3200	1900	
	MBP-R8-M7	.268-.346	6.8-8.8	.261-.272	.530	.125	3500	1900	
	MBP-R8-M8	.308-.387	7.8-9.8	.261-.272	.530	.125	3500	1900	
	MBP-R8-M9	.346-.425	8.8-10.8	.261-.272	.530	.125	3500	1900	
	MBP-R8-M10	.387-.466	9.8-11.8	.261-.272	.530	.125	3500	1900	
	MBP-R8-M11	.425-.504	10.8-12.8	.261-.272	.530	.125	3500	1900	
	MBP-R8-M12	.466-.545	11.8-13.8	.261-.272	.530	.125	3500	1900	
	MBP-R8-M13	.504-.583	12.8-14.8	.261-.272	.530	.125	3500	1900	
	5/16"	MBP-R10-3	.150-.250	3.8-6.4	.3275-.340	.655	.152	5000	2960
MBP-R10-4		.200-.300	5.1-7.6	.3275-.340	.655	.152	5000	2960	
MBP-R10-5		.250-.350	6.4-8.9	.3275-.340	.655	.152	5000	2960	
MBP-R10-6		.300-.400	7.6-10.2	.3275-.340	.655	.152	5000	2960	
MBP-R10-7		.350-.450	8.9-11.4	.3275-.340	.655	.152	5000	2960	
MBP-R10-8		.400-.500	10.2-12.7	.3275-.340	.655	.152	5000	2960	
5/16"	MBP-R10-10	.500-.600	12.7-15.2	.3275-.340	.655	.152	5000	2960	
	Clearance Version*								
	1/4"	MBCP-R8-M3	.110-.189	2.8-4.8	.261-.272	.530	.125	2400	1600
		MBCP-R8-M4	.150-.229	3.8-5.8	.261-.272	.530	.125	2500	1600
		MBCP-R8-M5	.189-.268	4.8-6.8	.261-.272	.530	.125	3000	1600
		MBCP-R8-M6	.229-.306	5.8-7.8	.261-.272	.530	.125	3000	1600
		MBCP-R8-M7	.268-.346	6.8-8.8	.261-.272	.530	.125	3000	1600
		MBCP-R8-M8	.308-.387	7.8-9.8	.261-.272	.530	.125	3000	1600
		MBCP-R8-M9	.346-.425	8.8-10.8	.261-.272	.530	.125	3000	1600
		MBCP-R8-M11	.425-.504	10.8-12.8	.261-.272	.530	.125	3000	1600
MBCP-R8-M13		.504-.583	12.8-14.8	.261-.272	.530	.125	3000	1600	
MBCP-R8-M16		.622-.701	15.8-17.8	.261-.272	.530	.125	3000	1600	

* MBCP: Please refer to coordination drawings for specifications.

NOTE: Part numbers listed reflect typical stock. Additional Head Styles, material, diameter and grips may be available. All parts may be subject to minimum order.

Installation Tooling

DIAMETER	TOOL	NOSE ASSEMBLY	TYPE
3/16"	2024**	99-3303	Pneudraulic
	2480	99-3303	Hydraulic
	BV4500-118	99-3303	Battery
1/4"	2024*	99-3305	Pneudraulic
	2480	99-3305	Hydraulic
	BV4500-118	99-3305	Battery
5/16"	2581	99-3307	Hydraulic
	256	99-3307	Pneudraulic

*Preferred Tool. **BV4500-118K2 includes Two Batteries, One Charger, Carrying Case.

HuckLok®

Wide Grip-Range and Double-Locking Action for a Secure Hold

Featuring a wide grip range and unique double-locking action, the HuckLok® blind rivet combines high shear strength and high pull-up force. Its double-locking action consistently secures the assembly from both sides, resulting in maximum hold and joint integrity. Its large, blind-side footprint prevents pull-through, especially when joining thin or lightweight materials, such as plastics, composites, or any kind of pliable material. Positive mechanical pin retention ensures structural integrity, while annular grooves keep pressure on the back side.

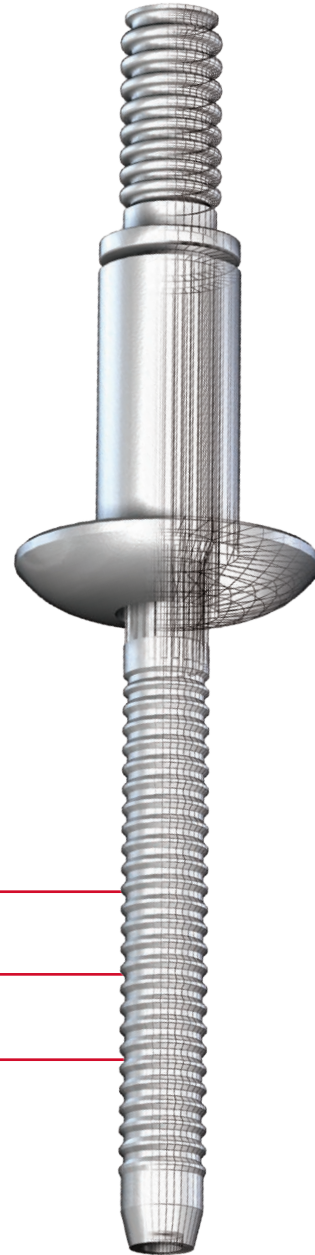

Available Sizes 3/16", 1/4"

Materials Steel

Headstyles Protruding, Truss, 100° Oval Flush



- ✓ Unique bulbing system for superior blind side strength
- ✓ Wide grip-range and unique double-locking action
- ✓ Positive mechanical bolt retention ensures structural integrity
- ✓ Large, blind-side footprint prevents pull-through
- ✓ Annular grooves keep pressure on the back side

Secure, Fast Installation

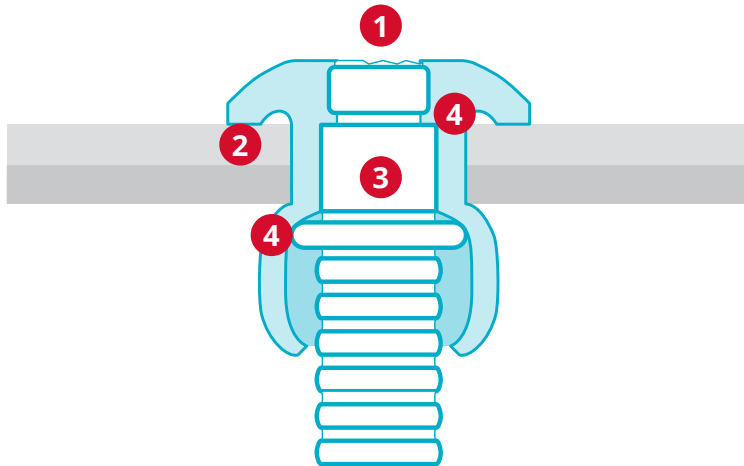

- 1 Breaking flush throughout its grip range, HuckLok allows at-a-glance verification of installation accuracy.
- 2 Undercut fillet allows seating in burred holes.
- 3 Solid pin provides exceptionally high strength in the shear plane.
- 4 Lock groove on pin engages shoulder on rivet head, while the extruded support ring double locks the pin within the bulb.

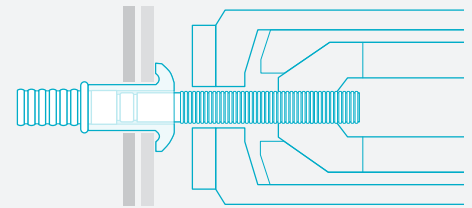

- 1 Insert the fastener into the hole and slip the installation tool over the pintail.

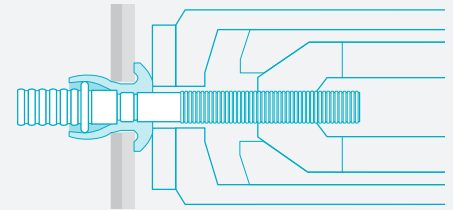

- 2 Press the trigger to initiate pulling action. As the tool pulls on the pintail, the shear ring feature on the pin pulls inside the sleeve fully expanding the diameter and drawing the work pieces together.

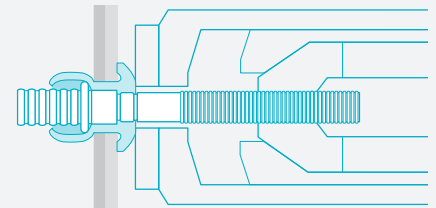

- 3 Continued pulling on the pintail expands the sleeve to maximum allowable diameter. As the shear ring reaches the backside of the work piece it breaks and catches on the tapered annular grooves, keeping high pressure on the blind side of the work pieces as the pin continues to draw down inside the sleeve.

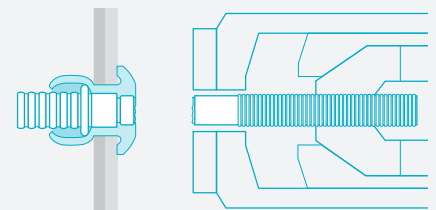

- 4 A solid circle lock between the pin and sleeve is formed just prior to the pin breaking flush with the sleeve head, completing the installation

HuckLok® Data and Tooling



Steel Rivet - Steel Mandrel

DIAMETER	PART NO.	FINISH	GRIP RANGE	HOLE SIZE	[B] HEAD DIA (MAX)	[C] HEAD HEIGHT (MAX)	MIN. SHEAR (LBF)	MIN. TENSILE (LBF)
Protruding Head								
3/16"	HKLP-R6-5	zinc plate clear chromate	.062-.312	.191-.201	.395	.101	1900	1000
	HKLP-R6-5U	zinc plate yellow chromate	.062-.312	.191-.201	.395	.101	1900	1000
	HKLP-R6-5GAT	zinc plate clear chromate plus sealer	.062-.312	.191-.201	.395	.101	1900	1000
	HKLP-R6-7	zinc plate clear chromate	.187-.437	.261-.272	.395	.101	1900	1000
1/4"	HKLP-R8-6	zinc plate clear chromate	.100-.375	.261-.272	.530	.122	3500	1900
	HKLP-R8-6U	zinc plate yellow chromate	.100-.375	.261-.272	.530	.122	3500	1900
	HKLP-R8-6S	PVC sealant	.100-.375	.261-.272	.530	.122	3500	1900
	HKLP-R8-7	zinc plate clear chromate	.187-.437	.261-.272	.530	.122	3500	1900
	HKLP-R8-7U	zinc plate yellow chromate	.187-.437	.261-.272	.530	.122	3500	1900
	HKLP-R8-7BL	zinc plate black chromate	.187-.437	.261-.272	.530	.122	3500	1900
	HKLP-R8-7A3	zinc plate clear chromate with glass seal	.187-.437	.261-.272	.530	.122	3500	1900
	HKLP-R8-10	zinc plate clear chromate	.375-.625	.261-.272	.530	.122	3500	1900
	HKLP-R8-10U	zinc plate yellow chromate	.375-.625	.261-.272	.530	.122	3500	1900
	HKLP-R8-12	zinc plate clear chromate	.500-.750	.261-.272	.530	.122	3500	1900
HKLP-R8-14	zinc plate clear chromate	.625-.875	.261-.272	.530	.122	3500	1900	
HKLP-R8-18	zinc plate clear chromate	.875-1.125	.261-.272	.530	.122	3500	1900	
Truss Head								
1/4"	HKLT-R8-6	zinc plate clear chromate	.100-.375	.261-.272	.592	.122	3500	1900

NOTE: Part numbers listed reflect typical stock. Additional Head Styles, material, diameter and grips may be available. All parts may be subject to minimum order.



Installation Tooling

DIAMETER	TOOL	NOSE ASSEMBLY	TYPE
3/16"	2022	99-3303	Pneudraulic
	2024*	99-3303	Pneudraulic
	2480	99-3303	Hydraulic
	BV4500-118	99-3303	Battery
1/4"	2022	99-3305	Pneudraulic
	2024*	99-3305	Pneudraulic
	2480	99-3305	Hydraulic
	BV4500-118	99-3305	Battery

*Preferred Tool.

Auto-Bulb®

An Easy-to-Install Bulbing Fastening System for Superior Blind Side Strength

For use in a variety of applications including thin materials or delicate composites, Huck Auto-Bulb® is the perfect solution. Easy-to-install, it works by clamping the joint with a large diameter head and broad, blind-side bulb, which spreads to diffuse the load over a large area, ensuring permanent clamp. Available in steel and 400 stainless steel for enhanced corrosion resistance.

This high-reliability fastener offers an easy-to-use lead-in point in the form of a tapered, hole-seeking tip, which means fast, reliable installation. Because of its high pull-out strength, Auto-Bulb is an ideal choice for use in thin materials, and in oversized, misaligned, or slotted holes. Unlike other bulbing blind fasteners, Auto-Bulb's uniquely engineered bulbing system creates superior blind-side bearing strength with the bulb always forming on the sheet line. Its positive mechanical pin retention ensures structural integrity.

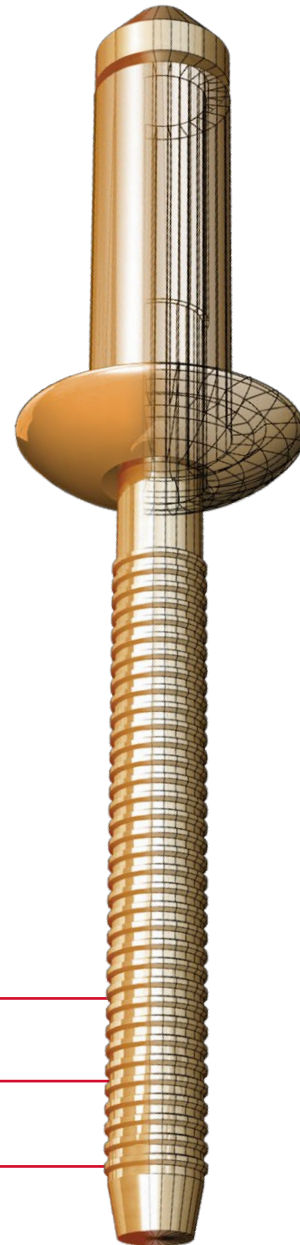

Available Sizes 3/16", 1/4", 3/8"

Materials Steel and 400 Series Stainless Steel

Headstyles Protruding, oval countersunk

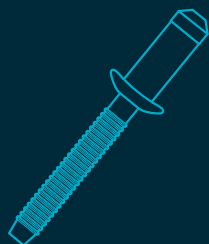

- ✓ Unmatched installation speed
- ✓ Superior blind side strength
- ✓ Minimal blind side protrusion prior to installation
- ✓ Vibration resistance
- ✓ Steel and corrosion resistance 400 stainless steel
- ✓ High pull-out strength in thin materials
- ✓ Aesthetic blind side appearance

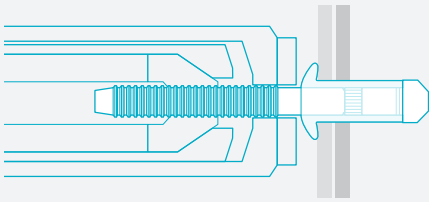

1
Insert the fastener into the hole and slip the installation tool over the pintail.

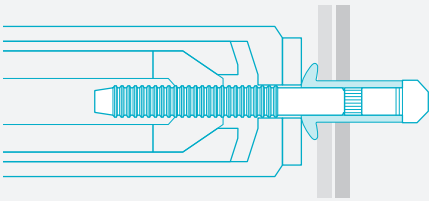

2
Press the trigger to initiate pulling action. As the tool pulls on the pintail, the solid pin head captures the end of the sleeve and acts to initiate bulb formation and draws the work pieces together.

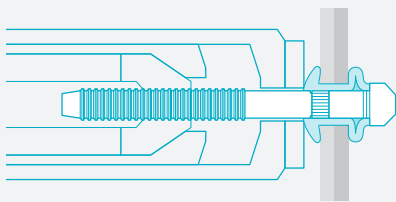

3
Continued pulling on the pintail expands the bulb to maximum allowable diameter.

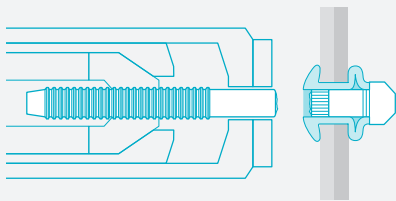

4
A spline feature on the pin comes into contact with a step on the sleeve creating an interference lock between the pin and sleeve and the pin breaks. The pin will break close to flush in minimum grip and below flush as the grip increases.

Secure, Fast Installation

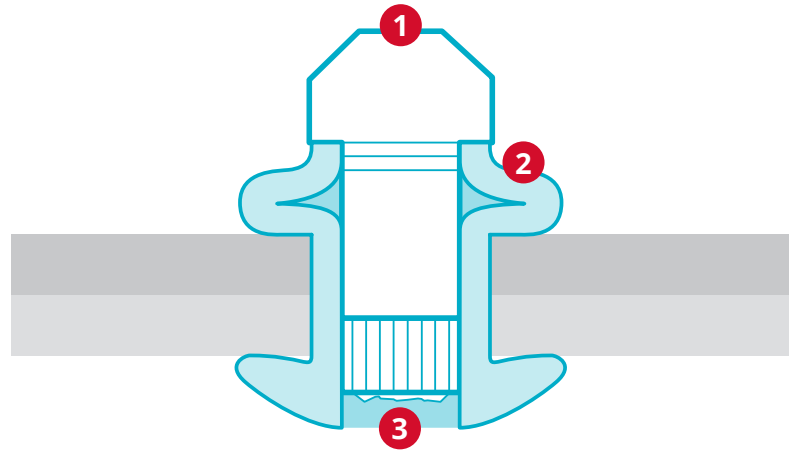

- 1 Tapered hole-seeking tip for quick and easy installation.
- 2 Unique band annealed bulbing system for superior blind side strength.
- 3 Positive mechanical pin retention ensures structural integrity.

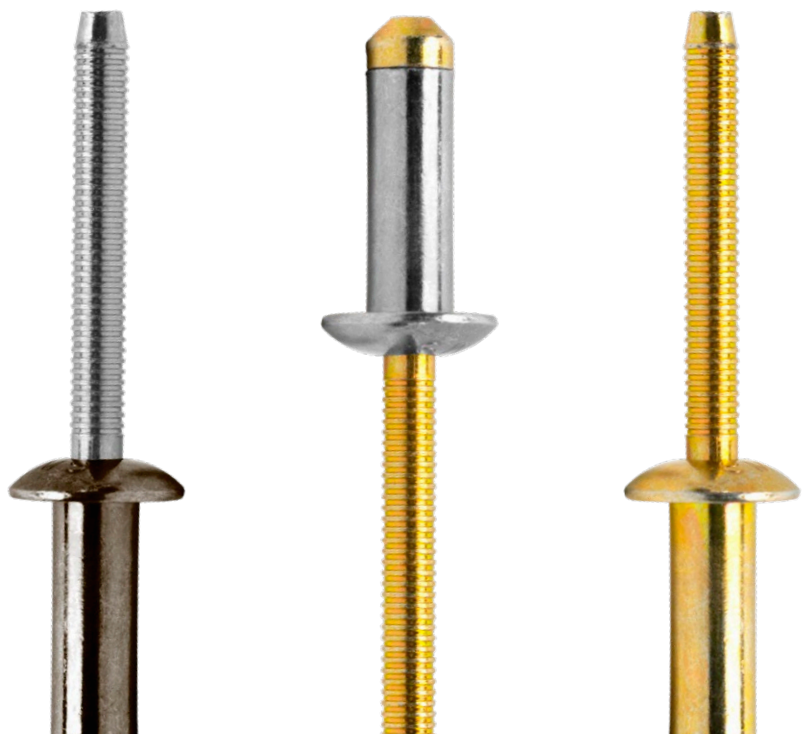

Data & Dimensions

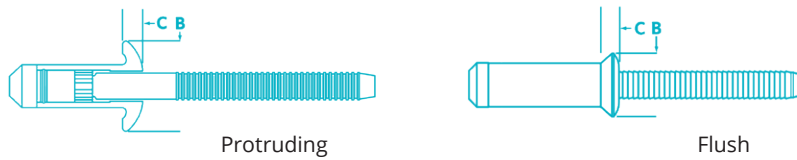

430 Stainless Steel

DIAMETER	PART NO.	GRIP RANGE (IN)	GRIP RANGE (MM)	HOLE SIZE	[B] HEAD DIA	[C] HEAD HEIGHT	SHEAR MIN (LBF)	TENSILE MIN (LBF)
Protruding Head								
1/4"	ABP-4U8-M3	.110-.189	2.8-4.8	.261-.272	.489-.535	.104-.130	2600	1600
	ABP-4U8-M4	.150-.229	3.8-5.8	.261-.272	.489-.535	.104-.130	2600	1600
	ABP-4U8-M5	.189-.268	4.8-6.8	.261-.272	.489-.535	.104-.130	2600	1600
	ABP-4U8-M6	.229-.308	5.8-7.8	.261-.272	.489-.535	.104-.130	2600	1600
	ABP-4U8-M7	.268-.346	6.8-8.8	.261-.272	.489-.535	.104-.130	2600	1600
	ABP-4U8-M8	.308-.387	7.8-9.8	.261-.272	.489-.535	.104-.130	2600	1600
	ABP-4U8-M9	.346-.425	8.8-10.8	.261-.272	.489-.535	.104-.130	2600	1600
	ABP-4U8-M10	.387-.466	9.8-11.8	.261-.272	.489-.535	.104-.130	2600	1600
	ABP-4U8-M11	.425-.504	10.8-12.8	.261-.272	.489-.535	.104-.130	2600	1600
	ABP-4U8-M13	.504-.583	12.8-14.8	.261-.272	.489-.535	.104-.130	2600	1600

NOTE: Part numbers listed reflect typical stock. Additional Head Styles, material, diameter and grips may be available. All parts may be subject to minimum order.

Installation Tooling

DIA.	TOOL	NOSE ASSEMBLY	TYPE
3/16"	2022	99-3303	Pneudraulic
	2024*	99-3303	Pneudraulic
	2480	99-3303	Hydraulic
	BV4500-118	99-3303	Battery
1/4"	2022	99-3305	Pneudraulic
	2024*	99-3305	Pneudraulic
	2480	99-3305	Hydraulic
	BV4500-118	99-3305	Battery

*Preferred Tool.

Magna-Tite®

All-Aluminum Fastener Ideal for Thin or Low-Strength Materials

The Huck Magna-Tite® is a specialized aluminum structural rivet fastener that's well-suited for use in oversized holes and repair applications. Its wide, blind-side bulb makes it ideal for installation in thin or low-strength materials such as aluminum, fiberglass, and plastic. Unlike other bulbing blind fasteners, the Huck Magna-Tite has a unique embedded sealant applied between the pin and sleeve.



Available Sizes 3/16", 1/4"

Materials Aluminum

Headstyles Protruding, Shavable, Low Profile, 100° Oval Flush

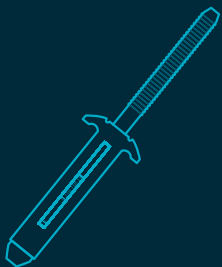

- ✓ Unmatched installation speed
- ✓ Superior blind side strength
- ✓ Minimal blind side protrusion prior to installation
- ✓ Vibration resistance
- ✓ Steel and corrosion resistance 400 stainless steel
- ✓ High pull-out strength in thin materials
- ✓ Aesthetic blind side appearance

Secure, Fast Installation

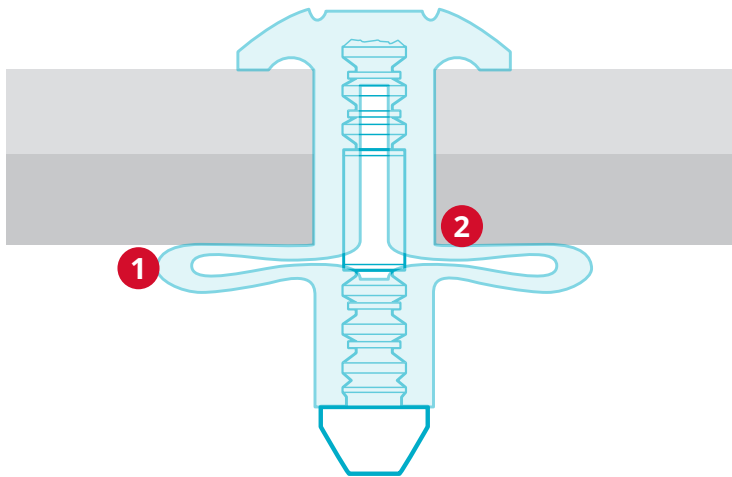

- 1 Large blind-side footprint for installation in thin or compressible materials where controlled strength is required.
- 2 Unique embedded sealant applied between the pin and sleeve.

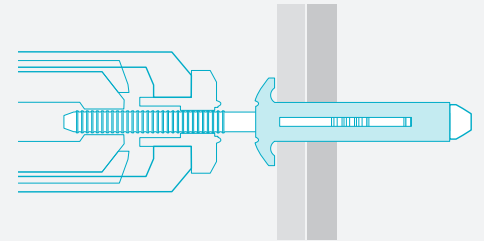

Insert the fastener into the hole and slip the installation tool over the pintail.

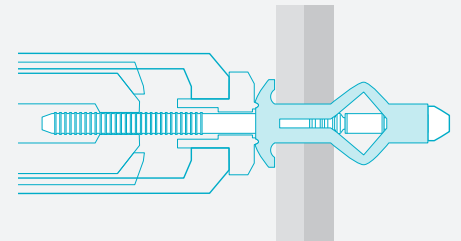

Press the trigger to initiate pulling action. As the tool pulls on the pintail, the pin (mandrel) expands the sleeve and begins drawing the work pieces together.

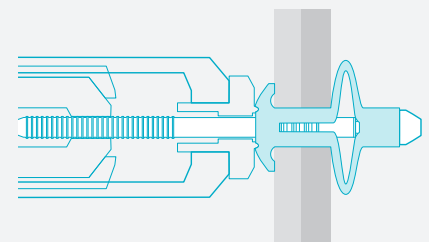

Continued pulling on the pintail expands the sleeve to maximum allowable diameter. High pressure is kept on the blind side of the work pieces as the pin continues to draw down inside the sleeve.

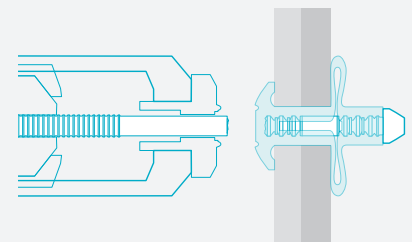

A solid circle lock between the pin and sleeve is formed just prior to the pin breaking flush with the sleeve head, completing the installation.

Magna-Tite® Data and Tooling

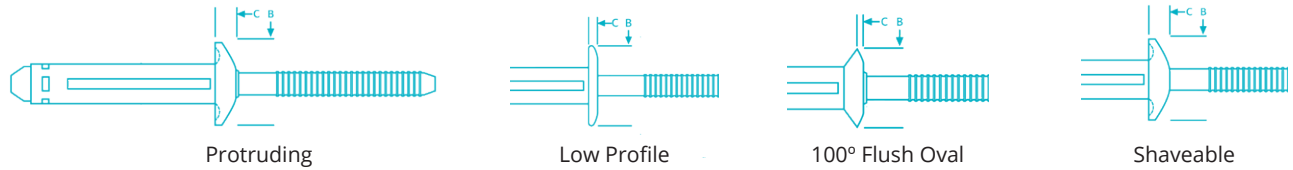

Aluminum Rivet/Aluminum Mandrel

DIAMETER	PART NO.	SEALANT	GRIP RANGE	HOLE SIZE	[B] HEAD DIA (MAX)	[C] HEAD HEIGHT (MAX)	MINIMUM SHEAR (LBF)	MINIMUM TENSILE (LBF)
Protruding Head								
3/16"	MTP-B6-5S	PVC	.050-.312	.205-.221	.463	.113	550	390
	MTP-B6-6	—	.100-.375	.205-.221	.463	.113	550	390
	MTP-B6-6S	PVC	.100-.375	.205-.221	.463	.113	550	390
	MTP-B6-8S	PVC	.250-.500	.205-.221	.463	.113	550	390
	MTP-B6-10S	PVC	.375-.625	.205-.221	.463	.113	550	390
	MTP-B6-12S	PVC	.500-.750	.205-.221	.463	.113	550	390
1/4"	MTP-B8-4	—	.040-.250	.250-.263	.543	.120	950	575
	MTP-B8-4S	PVC	.040-.250	.250-.263	.543	.120	950	575
	MTP-B8-6	—	.125-.375	.250-.263	.543	.120	950	575
	MTP-B8-6S	PVC	.125-.375	.250-.263	.543	.120	950	575
	MTP-B8-8S	PVC	.250-.500	.250-.263	.543	.120	950	575
	MTP-B8-10S	PVC	.375-.625	.250-.263	.543	.120	950	575
	MTP-B8-12S	PVC	.500-.750	.250-.263	.543	.120	950	575
Oval Head								
3/16"	MTV-B6-5S	PVC	.070-.312	.205-.221	.365	.043	550	390
	MTV-B6-7S	PVC	.160-.410	.205-.221	.365	.043	550	390
	MTV-B6-8S	PVC	.250-.500	.205-.221	.365	.043	550	390
	MTV-B6-10S	PVC	.375-.625	.205-.221	.365	.043	550	390
	MTV-B6-12S	PVC	.500-.750	.205-.221	.365	.043	550	390
Low Profile Head								
3/16"	MTLP-B6-4	—	.050-.250	.205-.221	.452	.061	300*	390
	MTLP-B6-8	—	.187-.500	.205-.221	.452	.061	300*	390
	MTLP-B6-12	—	.375-.750	.205-.221	.452	.061	300*	390
	MTLP-B6-12X	—	.050-.750	.205-.221	.452	.061	300*	390
Shaveable Head								
3/16"	MTS-B6-8	—	.050-.500	.205-.221	.463	.123	550	390
	MTS-B6-8S	PVC	.050-.500	.205-.221	.463	.123	550	390
	MTS-B6-12S	PVC	.050-.750	.205-.221	.463	.123	550	390

*550 lbs. minimum in minimum grip only

NOTE: Part numbers listed reflect typical stock. Additional Head Styles, material, diameter and grips may be available. All parts may be subject to minimum order.

Installation Tooling

DIAMETER	TOOL	NOSE ASSEMBLY	INSERT	TYPE
3/16"	2024	99-3487-6MT	126969-Protruding** 126970-Flat**	Pneudraulic
	2480	99-3487-6MT	126969-Protruding** 126970-Flat**	Hydraulic
	BV4500-118	99-3487-6MT	Review Inserts for proper match to MT style	Battery
1/4"	2024	99-3487-6MT	126971-Protruding** 126972-Flat**	Pneudraulic
	2480	99-3487-6MT	126971-Protruding** 126972-Flat**	Hydraulic
	BV4500-118	99-3487-8MT	Review Inserts for proper match to MT style	Battery

** Insert Included with nose assembly.

BOM[®]

The Highest Strength Blind Oversized Fastener Available

Often used as a replacement for welding, Huck BOM[®] is so strong, one BOM (Blind, Oversized Mechanically locked) fastener can do the work of up to four conventional fasteners. Its unique push-and-pull installation design makes it ideal for military vehicles, auto suspensions, rail car assembly, and much more. BOM's high fatigue thread form extends the life of any structure. Offering accurate, easy, quick installation, BOM requires no special training or skills for operators.

Available Sizes 3/16", 1/4", 5/16", 3/8", 1/2", 5/8", 3/4"

Materials Steel

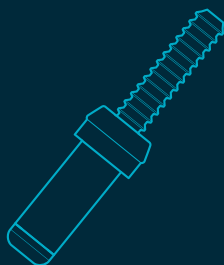
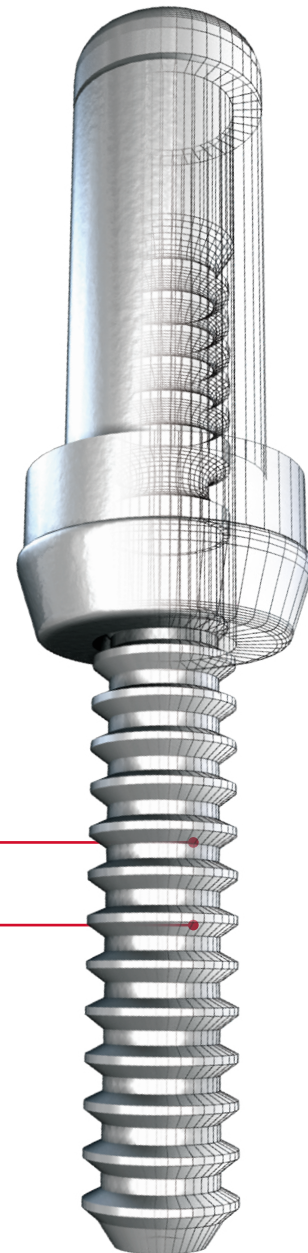

- ✓ Unmatched installation speed
- ✓ Low overall installed cost
- ✓ Vibration resistance
- ✓ Quiet non-torque tools
- ✓ No repetitive stress injuries
- ✓ Eliminates need for secondary operations
- ✓ No special training or skills required for operators

Secure, Fast Installation

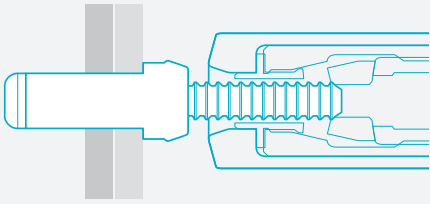

- 1** Insert the fastener into the hole and slip the installation tool over the pintail.

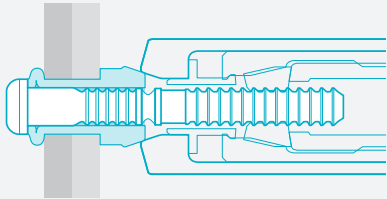

- 2** Press the trigger to initiate pulling action. As the tool pulls on the pintail, the unique collar design "stands off" the swaging action until the maximum allowable bulb is formed on the backside.

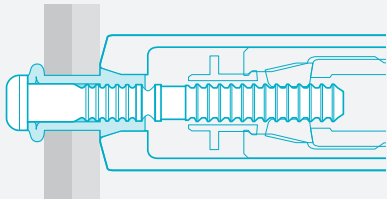

- 3** Continued pulling on the pintail draws the work pieces together and the swaging anvil overcomes the standoff and moves down the length of the collar, securely locking the collar to the pin.

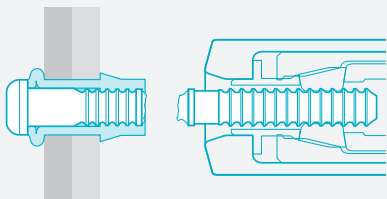

- 4** Once the collar is swaged, the tool ejects the fastener and releases the puller to complete the sequence.

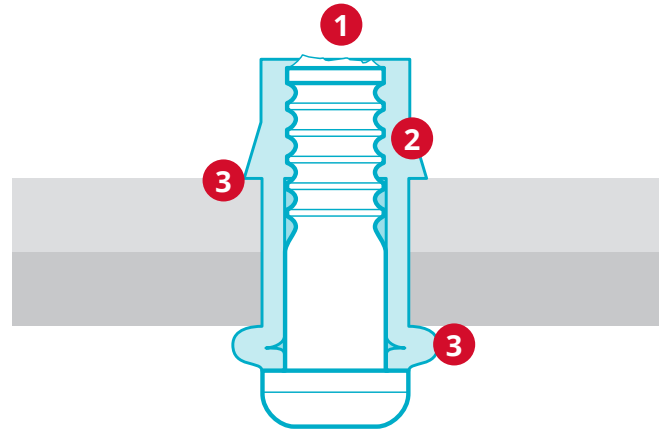

- 1 When the pin separates near flush, the BOM fastener is installed correctly. The BOM fastener does not require surface preparation, grinding or filling after installation.
- 2 The collar is locked to the pin through the "swaging" process, creating a high vibration resistant connection and the highest strength of any blind fastener.
- 3 Large bearing area on both sides of the work piece ensures a permanently held, tamper resistant joint.



BOM[®] Data and Tooling

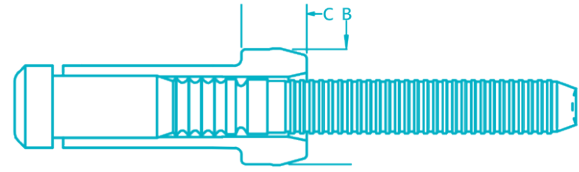

Steel Pin - Zinc Plated

DIAMETER	PART NO.	GRIP RANGE	HOLE SIZE	[B] HEAD DIA	[C] HEAD HEIGHT	MIN. SHEAR (LBF)	MIN. TENSILE (LBF)
1/4"	BOM-R8-3	.157-.219	.277-.292	.368-.380	.205-.225	5100	3250
	BOM-R8-4	.220-.281	.277-.292	.368-.380	.205-.225	5100	3250
	BOM-R8-5	.282-.344	.277-.292	.368-.380	.205-.225	5100	3250
	BOM-R8-6	.345-.406	.277-.292	.368-.380	.205-.225	5100	3250
	BOM-R8-7	.407-.469	.277-.292	.368-.380	.205-.225	5100	3250
	BOM-R8-8	.470-.531	.277-.292	.368-.380	.205-.225	5100	3250
	BOM-R8-9	.532-.594	.277-.292	.368-.380	.205-.225	5100	3250
	BOM-R8-10	.595-.656	.277-.292	.368-.380	.205-.225	5100	3250
	BOM-R8-11	.657-.719	.277-.292	.368-.380	.205-.225	5100	3250
5/16"	BOM-R10-4	.188-.312	.348-.368	.468-.478	.266-.278	8050	5200
	BOM-R10-6	.313-.437	.348-.368	.468-.478	.266-.278	8050	5200
	BOM-R10-8	.438-.562	.348-.368	.468-.478	.266-.278	8050	5200
	BOM-R10-10	.563-.687	.348-.368	.468-.478	.266-.278	8050	5200
	BOM-R10-12	.688-.812	.348-.368	.468-.478	.266-.278	8050	5200
3/8"	BOM-R12-4	.188-.312	.413-.435	.553-.563	.315-.327	11100	7250
	BOM-R12-6	.313-.437	.413-.435	.553-.563	.315-.327	11100	7250
	BOM-R12-8	.438-.562	.413-.435	.553-.563	.315-.327	11100	7250
	BOM-R12-10	.563-.687	.413-.435	.553-.563	.315-.327	11100	7250
	BOM-R12-12	.688-.812	.413-.435	.553-.563	.315-.327	11100	7250
1/2"	BOM-R16-10	.813-.937	.413-.435	.553-.563	.315-.327	11100	7250
	BOM-R16-12	.938-1.062	.413-.435	.553-.563	.315-.327	11100	7250
5/8"	BOM-R20-4GA	.251-.500	.687-.728	.925-.941	.507-.545	28500	20500
	BOM-R20-8GA	.501-.750	.687-.728	.925-.941	.507-.545	28500	20500
	BOM-R20-12GA	.751-1.000	.687-.728	.925-.941	.507-.545	28500	20500
	BOM-R20-16GA	1.001-1.250	.687-.728	.925-.941	.507-.545	28500	20500
	BOM-R20-20GA	1.251-1.500	.687-.728	.925-.941	.507-.545	28500	20500
3/4"	BOM-R24-4GAG	.251-.500	.828-.873	1.110-1.130	.637-.654	45100	29100
	BOM-R24-8GAG	.501-.750	.828-.873	1.110-1.130	.637-.654	45100	29100
	BOM-R24-12GAG	.751-1.000	.828-.873	1.110-1.130	.637-.654	45100	29100
	BOM-R24-16GAG	1.001-1.250	.828-.873	1.110-1.130	.637-.654	45100	29100

NOTE: Part numbers listed reflect typical stock. Additional materials, diameters and grips may be available. All parts may be subject to minimum order.

Installation Tooling

DIAMETER	TOOL	NOSE ASSEMBLY	TYPE
3/16"	256	99-1053	Pneudraulic
	2480	99-994	Hydraulic
	2581	99-1053	Hydraulic
	BV4500-118	99-994	Battery
1/4"	256	99-830-1	Pneudraulic
	2581	99-830-1	Hydraulic
5/16"	256	99-769	Pneudraulic
	2581	99-769	Hydraulic
	2600	99-3119	Hydraulic
3/8"	256	99-1272*	Pneudraulic
	2581	99-1272	Hydraulic
	2600	99-3122	Hydraulic
1/2"	2624	99-5107	Hydraulic
	2624PTD	99-5106	Hydraulic
5/8"	2624	99-5102	Hydraulic
	3585	99-5102	Hydraulic
3/4"	3585	99-5103	Hydraulic

* For low volume applications.

FloorTight®

The Only Controlled, Self-Countersinking Blind Fastener Commercially Available

Originally designed for large vehicle flooring installations, Huck® FloorTight® is ideal for all wood-to-metal applications, especially plywood and plymetal. FloorTight's self-countersinking head eliminates the secondary counterboring process in plywood, and eliminates dimpling in metals. Unlike screws that can be over-torqued or under-torqued, FloorTight ensures consistent, reliable installation every time.

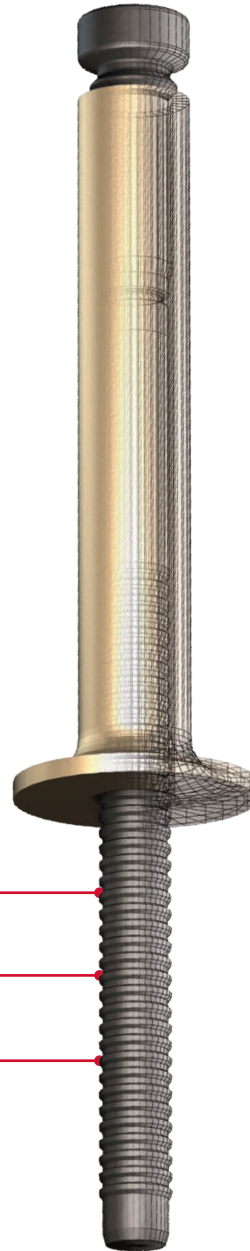

Available Sizes 1/4", 5/16"

Materials Steel

Headstyles Standard, Wide Flange, Plymetal, 90° Flush

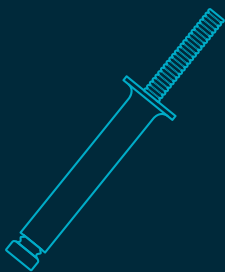

- ✓ Self-countersinking feature
- ✓ Large grip range
- ✓ Watertight
- ✓ Easy removal, no damage

Secure, Fast Installation

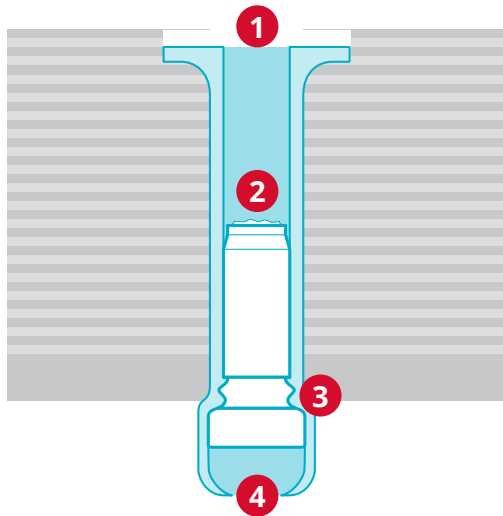

- 1 Self-countersinking head eliminates the counter-boring process in plywood, as well as dimpling in plymetal floors.
- 2 A high-strength pin locks in place within the shear plane for added holding power and durability.
- 3 360° internal locking feature creates a solid mechanical lock to prevent loosening.
- 4 Expansion within the weather-side stringer, coupled with the 360° internal lock provides excellent moisture resistance on the weather side.

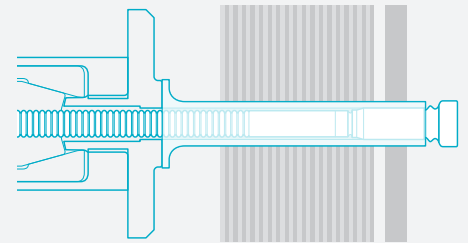

Insert fastener in hole. Apply installation tool.

1

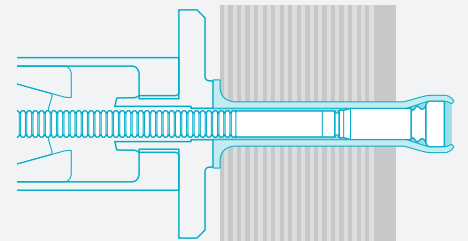

The Huck installation tool is placed over the pintail. When the trigger is pressed, the nose assembly jaws pull on the pintail, drawing the pin through the sleeve, causing the blind side sleeve to expand, partially setting the sleeve in the top sheet and pulling out all the sheet gap.

2

FloorTight® Data and Tooling

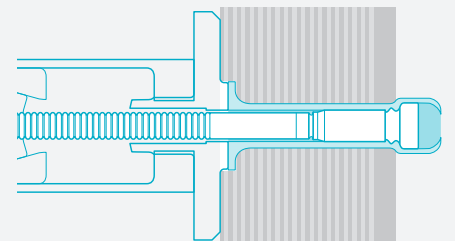

Continued pulling on the pintail forms a mechanical lock between the pin and sleeve end. The anvil on the installation tool then countersinks the fastener head into the top of the material to a preset depth set by the anvil. The anvil's large bearing face then prevents further travel of the sleeve head into the top material.

3

Steel Sleeves - Steel Mandrel

DIA.	PART NO.	GRIP RANGE	HOLE SIZE*	[B] HEAD DIA (MAX)	SHEAR MIN (LBF)	TENSILE MIN (LBF)
Plywood Floor						
5/16"	PWF-R10-20	.750-1.375	.328-.339	.650	4300	3000
	PWFMC-R10-20A3	.750-1.375	.328-.339	.650	4300	3000
Plymetal Floor						
5/16"	PMF-R10-20	.750-1.375	.328-.339	.590	4300	3000
	PMFMC-R10-20	.750-1.375	.328-.339	.590	4300	3000

* Minimum hole size is recommended for tightest seal.

Installation Tooling

DIA.	TOOL		NOSE ASSEMBLY	TYPE
1/4"	2581	2583**	99-3441	Hydraulic
	256		99-3441	Pneudraulic
5/16"	256		99-3452	Pneudraulic
	2581	2583**	99-3452	Hydraulic

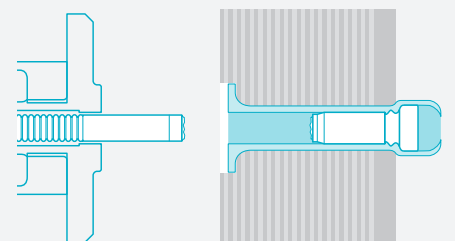

The pin is then separated in tension at the break neck groove.

4

Huck® Tools

The Industry's Best Installation Tooling

Designed to offer the highest levels of ergonomics, productivity, and long life, the Huck line of installation tooling reflects the same level of innovation and quality as its advanced fasteners. Whether it's a Huck hydraulic tool employed in high-volume installation of large diameter HuckBolts, or a smaller pneudraulic model used to install blind rivets and small diameter HuckBolts, you can count on these tools to deliver the industry's best value.



High Volume

A Wide Selection of Tooling Options

Huck offers a broad selection of hydraulic and pneudraulic tools, and a new battery-powered tool, in addition to Powerig® hydraulic power sources. Huck hydraulic installation tools are available to install a wide range of fasteners, from structural blind rivets to the largest HuckBolts. The Huck line of pneudraulic tools,

designed for use in repair work or in lower volume production applications, can effectively pull fasteners ranging from 3/32" blind rivets to 3/8" HuckBolts. The new lightweight, easy to use BV4500-118 Huck Range Force battery-powered tool can install most Huck blind rivets and HuckBolts up to 1/4" in diameter.



Powerful



Portable



Versatile



Ergonomic

Pneudraulic Tooling



244BT

The 244BT tool is designed for rapid installation of Huck BobTail 3/16" (5mm) and 1/4" (6mm) diameters. This lightweight tool features minimal moving parts, provides fast, uniform installations, and delivers optimum stroke for one-cycle installation of fasteners.



2025

Featuring an ergonomically designed handle, plated piston rods and an efficient in-line piston, the 2025 tool is ideal for high-volume production installation of blind fasteners and two-piece lockbolts, 1/4" and smaller diameter. An extended piston version (2025L) is available and an optional vacuum assist pintail collection system (2025V) can also be added.



256BT

Designed for quick installation of Huck BobTail fasteners, the 256BT tool features optimum stroke, one-cycle fastener installation, and minimal moving parts. The 256BT includes standard inline nose assemblies ranging from 5/16"



256

The Model 256 tool, designed for high-speed production applications, is able to install up to 20 fasteners per minute. This proven Huck tool is designed to install various fasteners from 3/16" (5mm), 1/4" (6mm), 5/16" (8mm), and 3/8" (10mm) blind fasteners and 2-piece lockbolts, including steel Magna-Grip fasteners. The Model 256 provides optimum stroke for one-cycle installations, and features a concentric (inline) pull piston and front gland design that allows for easy piston removal. The 256 is factory-tested for 1000 cycles, ensuring the tool's reliability, and its plated piston rods extend seal life and add to its overall durability. This proven production tool weighs only 11.1 pounds.



2022

The Model 2022 is a lightweight, high-speed tool that is well-suited for both production and maintenance/repair applications where 1/4" and smaller diameter (standard and extended grip) blind fasteners are used. The 2022 features a long-stroke, in-line piston for production rates of up to 30 installations per minute. The 2022's ergonomically designed handle and light weight (5.4 pounds) combine to minimize operator fatigue.



2024

The Model 2024 is designed for production volume installation of 1/4" and smaller diameter blind fasteners. This proven tool offers a number of outstanding features, including an ergonomically designed handle, plated piston rods, and an efficient in-line piston. An extended piston version (2024L) is available and an optional vacuum assist pintail collection system (2024V) can be added.



BV4500-118

The BV4500-118 Huck® Range Force™ by Makita® battery tool features an electronically adjustable pull force from 0 - 4500 lbf and a long 1.18" stroke to enable installation of most structural and non-structural blind rivets and two-piece HuckBolt® fasteners up to 1/4" in diameter. The 18V 5Ah battery is interchangeable with other Makita 18V batteries making this tool an ideal performer in portability, reliability and versatility.

Battery Tooling

Hydraulic Tooling



SFBTT8

Huck's proprietary Swageforward® BobTail® Tool, the SFBTT, makes the installation process quicker and easier by reducing the force required to install each fastener. The SFBTT8 is designed to install 1/4" (6mm), 5/16" (8mm), and 3/8" (10mm) fasteners.

More compact and lighter weight than previous HuckBolt production tooling, all Swageforward® BobTail® installation tools also offer greater operator flexibility as well as extended reach into difficult areas. For tight, space-constrained applications, these Huck Swageforward® BobTail® tools allow the operator to position his or her hand at a safe distance from the working structure during installation.



SF20

Offering all of the features of the Huck Swageforward® BobTail® Tool line, the SF20, delivers the power to install 1/2" (12mm), 14 mm, and 5/8" (16mm) BobTail HuckBolts® in high-speed, production environments.



SF32

The SF32 is Huck's Swageforward® BobTail® Tool designed for production value installation of 3/4" (20mm) BobTail fasteners.



SF46

The heavy duty SF46 Swageforward® BobTail® Tool is designed to install 7/8" (22mm) - 1" (25mm) BobTail® fasteners in a production environment.



2480

The Model 2480 is a very lightweight tool which provides for the high-speed installation of a wide range of HuckBolt® and Huck blind bolt fasteners. The tool has only one moving part, resulting in outstanding reliability and minimal maintenance. The tight centerline-to-edge measurement of the Model 2480 and its light weight (2.21 pounds) allow for its use in limited clearance areas.



2581

Featuring a reliable 2-piece cylinder and handle design, the Model 2581 is a lightweight, high-speed production tool. The 2581's hard plastic handle reduces the weight of the tool, while also ensuring that tool heat is not transferred to the operator. The simple construction of 2581, provides for increased reliability and minimal maintenance.



2582/2583

In addition to incorporating many of the features of the 2581, both the Model 2582 and 2583 feature an eccentric piston that allows for an improved center-to-edge measurement for tight clearance applications. The Model 2583 has a longer stroke, providing for one-cycle installation of a wide range of fasteners, including BobTails.



3585/3585PT

Offering durable construction, advanced hydraulics, and a safe, ergonomic design, both the Model 3585 and 3585PT installation tools provide for efficient installation of large diameter HuckBolts®. Both of these tools feature an improved piston and cylinder design for longer life. In addition, these tools' nose adapters can be removed through the back of the tool for ease of repair. The Model 3585 is designed to install a wide range of fasteners, including C50L®s and BobTail® HuckBolts®, while the Model 3585PT can efficiently install BobTail®, HuckSpin®, and HuckSpin II fasteners.

Huck Powerig® Power Sources

Combining advanced design and quality manufacturing, Huck Powerigs® offer both best-in-class performance and long product life. Whether for mobile or factory use, there is a Huck Powerig® hydraulic power source for the job. Choose from electric- or gasoline-powered portable units or larger rigs that can individually power up to three tools.



940

The Model 940 Powerig® is a portable unit sized for moderate production and repair applications. This model features rugged construction for durability in the field, and the choice of 115 or 220 Volt AC power. The Model 940 includes a handle for easy transport, simple adjustable hydraulic outputs, and quick-connect couplers for connecting installation tool hoses.

SPECIFICATIONS

Width: 1.5 in.
Length: 12.5
Height: 18 in.
Weight: 74.5 lbs. operational, 66 lbs. w/o hydraulic fluid
Power: electric, 115 or 220 volts, single phase

Flow Rate: 70 cu. in./min. @ 5,000 psi
Reservoir Capacity: 1.5 gal
Options: 220V, 60/50 hertz single phase, 250VDC, direct current



913F

The Huck Model 913F Powerig® is a portable, gasoline-powered, hydraulic power source designed to operate all Huck hydraulic installation equipment in applications where an air or electric power source is not available. This Powerig® hydraulic unit includes a roll cage for protection and to facilitate moving the unit to various work stations. The unit weighs approximately 175 pounds (78.7 kg) when filled with hydraulic fluid.

SPECIFICATIONS

Width: 21 in.
Length: 24 in.
Height: 27 in.
Weight: 122 lbs. w/o hydraulic fluid
Power: gasoline, Honda 5.5hp, 4 cycle, single cylinder air-cooled engine, point condenser ignition with 3 amp charging coil

Flow Rate:
 Pull 5800 psi, Max 8400 psi,
 Return 2800 psi, Max 6000 psi
Reservoir Capacity:
 5 gallons



918/918-5

The Model 918 and the 918-5 Powerigs® are the largest hydraulic units offered by Huck. Sized for high production applications, the Model 918 can operate up to two tools independently. The Model 918-5 can power up to three tools. These electrically powered models also deliver sufficient power to operate the tools up to 100 feet away. A 22-gallon reservoir stores hydraulic fluid, with a filter-strainer in the suction line to assure clean, filtered fluid.

SPECIFICATIONS

Width: 25 in.
Length: 44 in.
Height: 30 in.
Weight: 780 lbs. operational, 585 lbs. w/o hydraulic fluid

Power: electric, 220 or 440 volts 3 phase
Flow Rate: 2.0 gpm per tool station
Reservoir Capacity: 22 gal

NOTE: For additional tool details, refer to the specific fastener brochure or visit hfsindustrial.com



**HOWMET
AEROSPACE**

Howmet Fastening Systems

Industrial Division Brands



Huck, Marson, Recoil, Keysert, Camloc, Simmonds and Snep are trademarks of Howmet Aerospace Inc. and/or its subsidiaries.

North America

Waco Operations

PO Box 8117
8001 Imperial Drive
Waco, TX 76714-8117
Tel: +1 800-388-4825
Fax: +1 800-798-4825
sales.waco@howmet.com

Kingston Operations

1 Corporate Drive
Kingston, NY 12401
Tel: +1 800-278-4825
Fax: +1 845-334-7333
sales.kingston@howmet.com

Tracy Operations

1925 North MacArthur Drive
Tracy, CA 95376
Tel: +1 800-826-2884
Fax: +1 800-573-2645
sales.idg@howmet.com

Global

Telford Operations

Unit C, Stafford Park 7
Telford, Shropshire
England TF3 3BQ
Tel: +44 (0) 1952-290011
Fax: +44 (0) 1952-290459
sales.telford@howmet.com

Tokyo Operations (Japan & Korea)

8F CIRCLES Nihonbashi-
Bakurocho Bldg
1-5-12 Nihonbashi-Bakurocho
103-0002 Tokyo Japan
Tel: +81-3-5642-8360
Tel: +81-3-5642-8361 x8365
Fax: +81-3-5644-5772

Melbourne Operations

1508 Centre Road
Clayton, Victoria
Australia 3168
Tel: +613-8545-3333
Fax: +613-8545-3390
hfsmel.sales@howmet.com

Suzhou Operations

58 Yinsheng Road,
SIP Suzhou, Jiangsu
215126 China
Tel: +86-512-62863800-8888



ACE RIVET & FASTENER INC.

P: 905-792-2255

E: SALES@ACERIVET.COM

W: WWW.SALES@ACERIVET.COM

hfsindustrial.com

[YouTube.com/HFSIndustrial](https://www.youtube.com/HFSIndustrial)

The information contained in this publication is only for general guidance, and is not intended to create any warranty, express, implied, or statutory; all warranties are contained only in Howmet Fastening Systems' written quotations, acknowledgments, and/or purchase orders. It is recommended that the user secure specific, up-to-date data and information regarding each application and/or use of such products.

© 2020 Howmet Aerospace Inc. All rights reserved. HFS6735 0620
BobTail, C50L, Magna-Grip, C6L, Hucktainer, HuckLok, Magna-Lok, Auto-Bulb, Magna-Bulb, BOM, FloorTight, Magna-Tite, Powerig, Swageforward and Huck Spin are trademarks of Howmet Aerospace Inc. and/or its subsidiaries.